



HIGH-PRECISION, HIGH-SPEED
VERTICAL MACHINING CENTER

NX

5500 II



DN SOLUTIONS

NX 5500 II

The NX 5500 II vertical machining centers are designed with a thermal-symmetric bridge type structure to optimise precision and workpiece quality. High accuracy is also enhanced by the constant pre-load high speed spindle. Operator convenience is improved by optimum accessibility and operator functions.





IMPROVED SPINDLE RIGIDITY AND LIFE

- Improved spindle rigidity in low speed range and achieved long spindle life with constant pre-load spindle in high speed range.

STABLE BRIDGE TYPE STRUCTURE

- Thermal analysis of the symmetrical structure and minimal overhang of the bridge type machine structure provide optimal solution for high-speed / high-precision processing.

OPTIMIZED MOLD PROCESSING SOLUTION

- Thermal error compensation system, high speed spindle, high accuracy contour control, tool measurement system are provided as standard to improve mold processing performance.

BASIC STRUCTURE

NX II series have the Bridge type structure for high-performance, high-accuracy machining.

Bridge type structure

Thermal analysis of the symmetrical structure proves that this is the optimal solution for high precision machining of mild products.

Traver distance

X axis

900 mm 35.4 inch

Y axis

550 mm 21.7 inch

Z axis

500 mm 19.7 inch

Rapid traverse rate (X / Y / Z axis)

30 / 30 / 30 m/min

1181.1 / 1181.1 / 1181.1 ipm



Gravity Center Drive Structure

By minimizing the distance between gravity center and the feed drive center, the inertia movement is reduced allowing for faster feed rates and a more precise part.

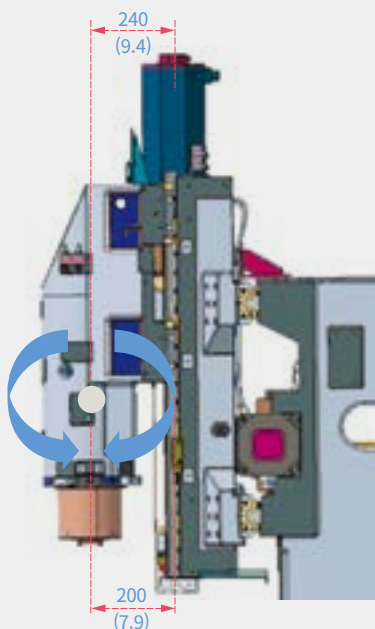

Unit: mm (inch)

Oil Separator (NX 5500 II)

Coolant and sliding oil are separated in the bed structure.

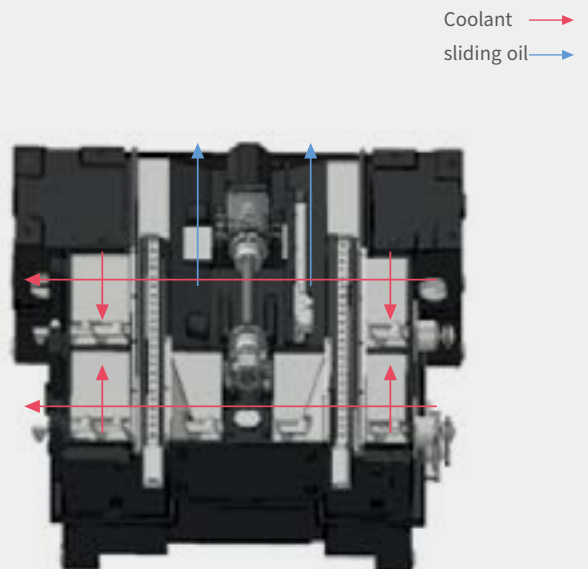

AXIS SYSTEM

The linear axes are equipped with roller linear Guideways for increased rigidity and a cooling system as standard features to minimize thermal error.

High-precision Travel System

Roller-type linear Guideways, high-rigidity coupling, and nut cooling system achieve high rigidity and outstanding linear axis accuracy of linear feed drive system.

Roller linear guideway



Rigid coupling



Ball screw nut cooling

Reduced thermal error of feed shafts
Stable rigidity of the feed system

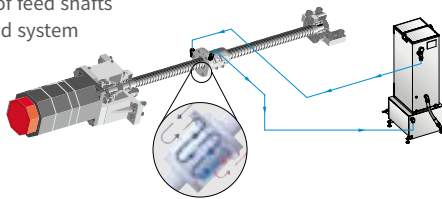

High power servo motor

The responsiveness of each axis feed system is improved by reducing the load / motor inertia ratio by 50%.

NX II series

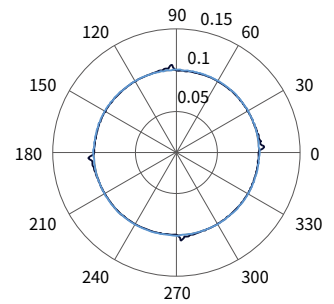

General processing system

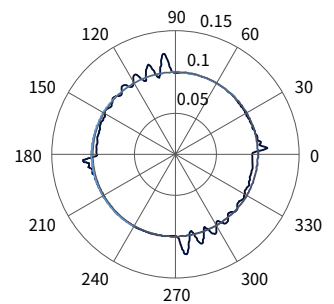

TOOL CHANGE SYSTEM

Rapid tool change reduce idling time and improves productivity.

Automatic tool changer

Enhanced productivity achieved with the high speed tool changer.

Tool storage capacity

30 ea

Tool to tool time

1.6 sec

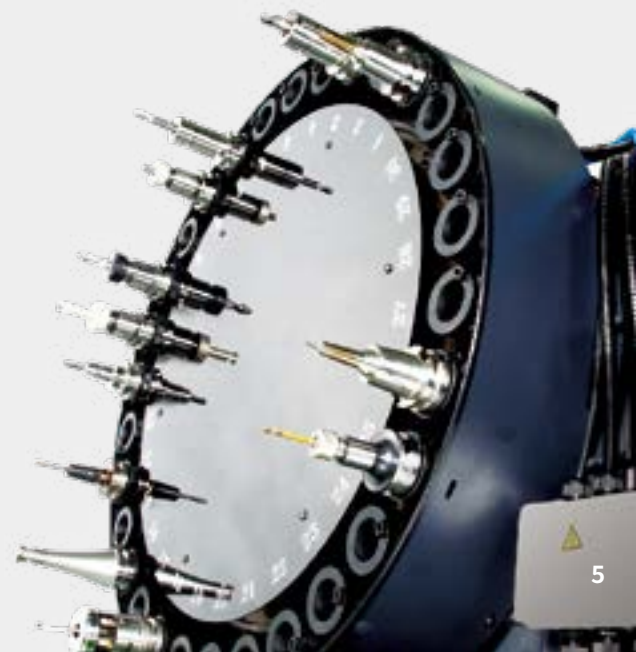

SPINDLE | TABLE

High-precision spindle and excellent dynamic balancing ensures stable surface accuracy by minimizing vibration in high speed cutting.

High-rigidity, high-precision spindle

Adopting a new constant preloading structure, improved spindle rigidity in low speed range and achieved long spindle life.

Max. spindle speed

20000 r/min

30000 r/min option

40000 r/min option

Spindle motor power

22 / 11 kW

30 / 15 Hp



Spindle Type and Tool Specification

High speed spindle up to 40000 r/min can be selected according to the workpieces material and cutting conditions. Dual-contact spindle can be selected to improve surface roughness and extend tool life by firm mounting of the tools on the spindle.

Item	20000 r/min		30000 r/min	40000 r/min
	std.	opt.	<small>option</small>	<small>option</small>
Spindle motor power kW (Hp)	22 / 11 (30 / 15)	22 / 11 (30 / 15)	18.5 / 13 (25 / 17)	5.5 / 3.7 (7 / 5)
Taper spindle	BBT 40	HSK-A63	HSK-F63	HSK-E40

Spindle Cooling System

Cooling system removes heat generated at the bearings and motor to minimize thermal error. The air-oil structure supplies high pressure air and lubricant to the spindle bearings to remove the heat generated at the bearings and extend service life of the machine tool.

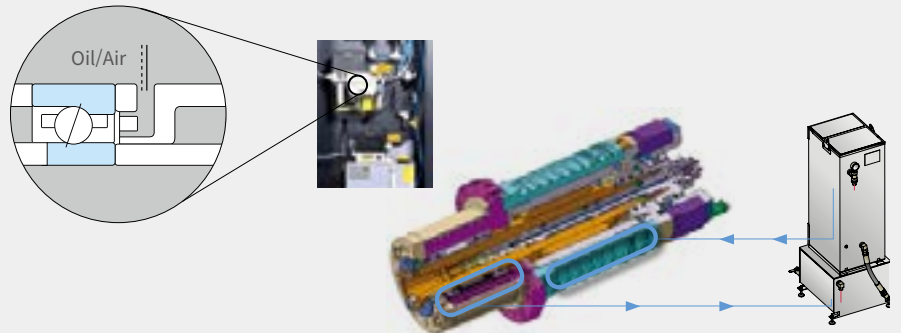

TABLE

Wide cutting area for cutting various workpieces.

Wide Cutting Area

The size and load capacity of the table allow the setting up and cutting of larger workpieces of various shapes.

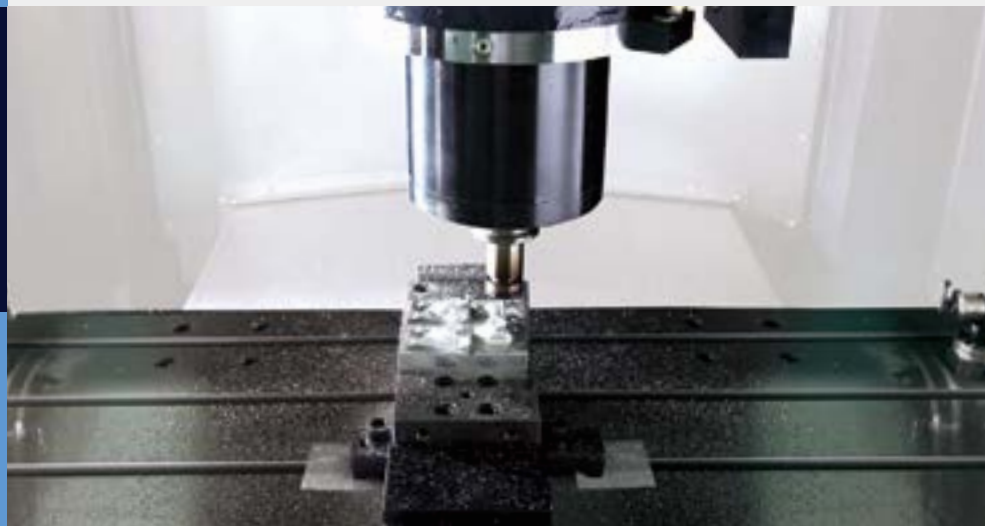

Item	Unit	NX 5500 II
Table size	mm (inch)	1000 x 550 (39.4 x 21.7)
Table loading capacity	kg (lb)	700 (1543)

MACHINING PERFORMANCE

To provide best cutting performance. Tool change time has been optimized to reduce non cutting time.

Cutting performance

Delivers excellent performance under diverse machining conditions.

NX 5500 II [20000 r/min]

Face mill (SM45C), Ø80mm (3.1 inch) Face mill (6Z)			
Machining removal rate cm ³ /min (inch ³ /min)	Spindle speed (r/min)	Feed rate mm/min (ipm)	
292 (17.8)	1750	3045 (155)	
R Cutter (NAK80), Ø50mm (2.0 inch) R cutter (3Z)			
Machining removal rate cm ³ /min (inch ³ /min)	Spindle speed (r/min)	Feed rate mm/min (ipm)	
115 (7)	1270	2290 (90)	
Face mill (GC25), Ø80mm (3.1 inch) Face mill (6Z)			
Machining removal rate cm ³ /min (inch ³ /min)	Spindle speed (r/min)	Feed rate mm/min (ipm)	
436 (26.6)	1750	2730 (107)	
R Cutter (NAK80), Ø50mm (2.0 inch) R cutter (3Z)			
Machining removal rate cm ³ /min (inch ³ /min)	Spindle speed (r/min)	Feed rate mm/min (ipm)	
101 (6.2)	960	1150 (45)	

* The results, indicated in this catalogue are provides as example. They may not be obtained due to differences in cutting conditions and environmental conditions during measurement.

Z Axis Fine Feeding

Machine	NX 5500 II	
Item	Pattern mold	
Material	HP4M	
Condition	Tool	F1 Ball Endmill
	Spindle speed / Feed rate	Speed : 19000 r/min Feed : 800mm/min (31.5 ipm)
	Time	134 hr

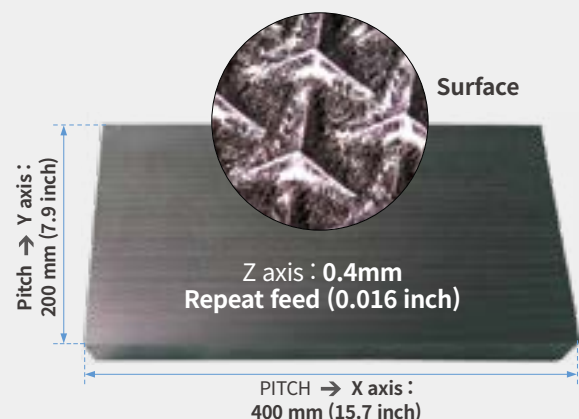

OPTIMIZED TOOL PROCESSING SOLUTION

Superior surface finishes and superior machining precision are achieved by using standard DN Solutions processing solutions, such as high speed / high precision contour control and thermal displacement compensation functions.

High Speed / High Precision Contour Control

- **DSQ1** (AICC2 _ 200 Block + Machining condition selection function)
- **DSQ2** option (DSQ1 + Data server [1GB])
- **DSQ3** option (DSQ2 + High speed processing _ 600 Block)



*DSQ : DN Solutions Super Quality

Tool Load Monitoring System (DTMM*)

The technology that protects the tool and machine when machining abnormal loads.

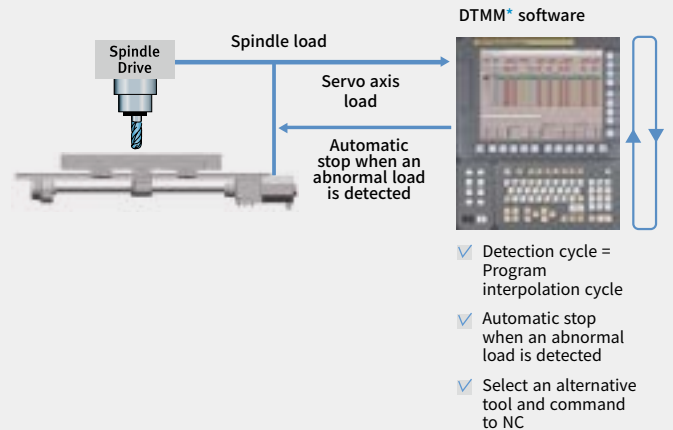

*DTMM : DN Solutions Tool load Monitoring for Machining Centers

The Optimal Feed Control (DAFC*)

Optimal feed control is ensured by spindle load detection that occurs in real time.

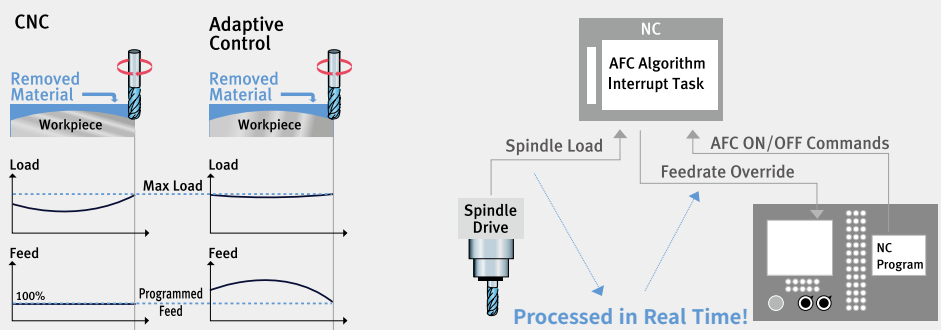

*DAFC : DN Solutions Adaptive Feedrate Control

Smart, multi-compensation thermal displacement technology

Realization of high-quality, high-precision machining achieved by thermal compensation of the spindle and machine structure.

Compensation of static spindle displacement

Compensates for changes in tool position caused by expansion of the spindle shaft during high speed operations.

Structural thermal displacement compensation

Compensates for any irregular deflection or expansion of the structure due to ambient temperature fluctuation by using multiple temperature sensors.

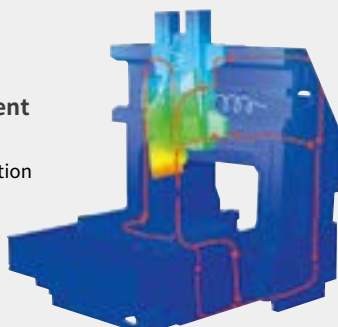

Thermal displacement compensation structure

Thermal displacement of the spindle, caused by heat accumulation, is compensated for using 5 algorithms including a smoothing function.

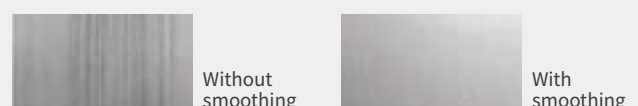
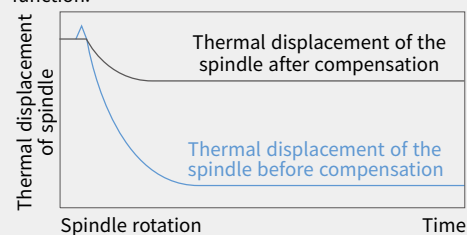

*DSTC : DN Solutions Smart Thermal Control

STANDARD | OPTIONAL SPECIFICATIONS

A range of options is available to suit individual requirements.

Description	Features	NX 5500 II	
Air blower		●	
Air gun		○	
Auto NC power off		○	
Auto workpiece measurement		○	
Automatic tool changer	24 Tools	X	
	30 Tools	●	
Automatic tool measurement	TS27R : RENISHAW	●	
	Z-MT : BLUM	○	
Automatic tool measurement master tool		○	
Chip conveyor	Hinge / Scraper / Drum filter type	○	
Coolant chiller		○	
Coolant gun		○	
Coolant Pump		●	
Coolant Tank		●	
DAFC		●	
DSQ	DSQ3	●	
DSTC		●	
DTMM		○	
Easy Operation Package	Tool load monitor	●	
	Alram / M-code / G-code / ATC recovery help	●	
	Table moving for setup / Easy work coordinate setting	●	
Electric cabinet air conditioner		○	
Electric cabinet light		○	
Electric cabinet line filter		○	
Gravity axis drop prevention		○	
Linear scale	X Axis	○	
	Y Axis	○	
	Z Axis	○	
MPG	1 MPG_PORTABLE TYPE	●	
	1 MPG_PORTABLE_W/ENABLE TYPE	○	
NC System	FANUC 31iB	●	
	HEIDENHAIN iTNC530	○	
NC system lcd size	10.4 inch_FANUC (Color)	X	
	15.1 inch_HEIDENHAIN (Color)	●	
Oil Skimmer	Belt type	○	
Power transformer		○	
Spindle motor power	22 / 11 kW (30 / 15 Hp)	●	
	18.5 / 13 kW (25 / 17 Hp)	○	
	5.5 / 3.7 kW (7 / 5 Hp)	○	
Spindle speed	20000 r/min	●	
	30000 r/min	○	
	40000 r/min	○	
Test bar		○	
Through spindle coolant	NONE	●	
	1.5 kW (2 Hp)_2.0 MPA (2 Hp)	○	
	5.5 kW (7.4 Hp)_7.0 MPA_DUAL BAG FILTER	○	
Work & tool counter	WORK / TOOL	○	
Customized special option	ANCHORING	J-BOLT	○
	COOLANT CHILLER		○
	AUTO TOOL LENGTH MEASUREMENT	MAKER/SPEC._RENISHA/NC4	○
		MAKER/SPEC._BLUM/MICROCOMPACT LASER CONTROL NT	○
		MAKER/SPEC._BLUM/Z-MT, Z-NANO HP	○
	AUTO TOOL BREAKAGE DETECTION	MAKER/SPEC._OMRON / D5A	○
		MAKER/SPEC._NIDDLE	○
	4TH AXIS PREPARATION CABLING FOR SERVO/1-PNEUMATIC PIPING	FACTORY READY MADE	○
	4TH AXIS WITH CNC R.TABLE	AVAILABLE SIZE_φ500	○
		SERVO MOTOR_EPENDS ON THE TABLE	○

*Please contact DN Solutions for detailed specifications.

● Standard ○ Optional x Not applicable

 Fire Safety Precautions | There is a high risk of fire when using non-water-soluble cutting fluids, processing flammable materials, neglecting the controlled and careful use of coolants and modifying the machine without the consent of the manufacturer. Always check the SAFETY GUIDELINES carefully before using the machine.

PERIPHERAL EQUIPMENT

Optional Equipments

Deliver excellent performance on diverse machining conditions.



1. Constant pre-load

Constant pressure spindle for high rigidity in low speed range and long life in high speed range.

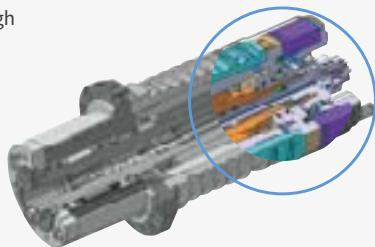

2. Standard chip pan and chip disposal

Chips are discharged to left side via screw conveyor.



3. Coolant chiller (strongly recommended)

option

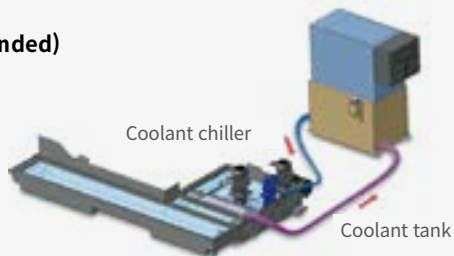

4. Machine temperature controlled spindle and axis drive cooling system

Accurate spindle cooling
Accurate ball screw cooling



5. Auto tool measuring equipment

Tool length measurement
Tool diameter measurement
Damaged tool detection

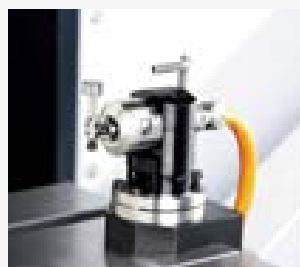

6. Graphite cutting solution **option**

Fine graphite powder sealing.
Wet/dry chip disposal

PERIPHERAL EQUIPMENT

Chip Disposal

Through rapid discharge of chips, it maintains a high degree of efficient processing, and supports the operator to work in improved environment by providing a variety of chip treatment devices.

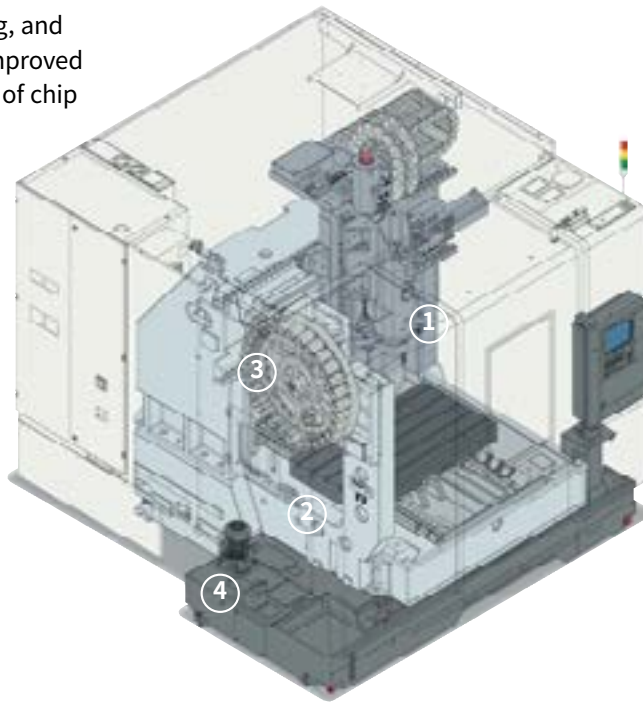

1. Coolant system

Side coolant chip air blower. Coolant residue stopping device

Spindle face coolant option

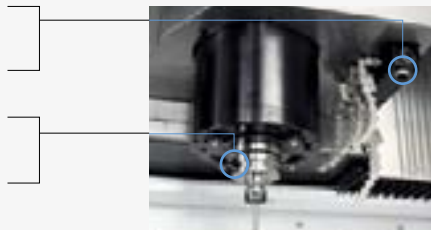

2. Screw conveyor

Two-rows screw type.



3. Barrier between the magazine and cutting area

The tool storage of the magazine is protected from the cutting area with an automatic door.



4. Chip conveyor option

NX 5500 II - Rear discharge



Hinge type



Scraper type



Drum filter type

Coolant Chiller (highly recommended) option

The coolant chiller lowers coolant temperature, helping to cool both the workpiece and tool during the machining operation. When using insoluble cutting oils, a coolant chiller is recommended to cool heated oil and preserve machining precision.

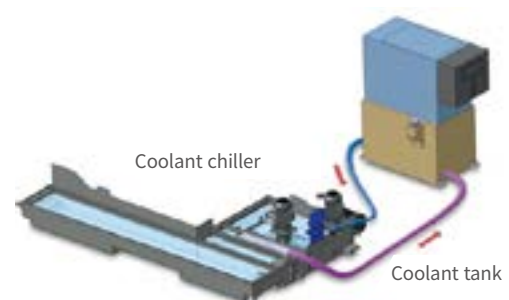

FANUC 31i/32i PLUS

Fanuc 31i/32i Plus maximizes customer productivity and convenience.

15" Touch screen + New OP

DN Solutions Fanuc 31iB/B5 Plus' operation panel enhances operating convenience by incorporating common-design buttons and layout. It features a Qwerty keyboard for fast and easy data input and operation.

Fanuc 31i/32i Plus

- 15-inch color display
- Intuitive and user-friendly design

USB and PCMCIA card QWERTY keyboard

- EZ-Guide i standard
- Ergonomic operator panel
- 4MB Memory
- Hot keys
- Enhance AICC BLOCK
- Touch pen provided as standard



iHMI touchscreen

iHMI provides an intuitive interface that uses a touchscreen for quick and easy operation.

Range of applications

Providing various applications related to planning, machining, improvement and utility, for customer convenience.

NUMERIC CONTROL SPECIFICATIONS

FANUC

Item	Specifications	F31iB Plus	
		NX 5500 II / NX 6500 II	
Controlled axis	Controlled axes	5 (X,Y,Z)	
	Simultaneously controlled axes	5 axes	
	Additional controlled Axis	Add 1 Axis (5th Axis)	●
Data input/output	Fast data server	○	
	Memory card input/output	●	
	USB memory input/output	●	
	Large capacity memory(2GB)*2	Note *2) Available Option only with 15" Touch LCD (iHMI Only)	○
Interface function	Embedded Ethernet	●	
	Fast Ethernet	○	
	Enhanced Embedded Ethernet function	●	
Operation	DNC operation	Included in RS232C interface.	●
	DNC operation with memory card		●
Program input	Workpiece coordinate system	G52 - G59	●
	Addition of workpiece coordinate system	G54.1 P1 X 48 (48 pairs)	●
	Tool number command		T4 digits
Feed function	Tilted working plane indexing command	G68.2 TWP	X
	AI contour control I	G5.1 Q_, 40 Blocks	X
	AI contour control II	G5.1 Q_, 200 Blocks	X
	AI contour control II	G5.1 Q_, 600 Blocks	X
	AI contour control II	G5.1 Q_, 1000 Blocks *1)	●
Operation guidance function	High smooth TCP		X
	EZ Guidei (Conversational Programming Solution)		●
	iHMI with Machining Cycle	Only with 15" Touch LCD standard *2)	X
Setting and display	EZ Operation package		●
	CNC screen dual display function		●
Network	FANUC MTConnect		⊕
	FANUC OPC UA		⊕
Others	Display unit	10.4" color LCD	X
		15" color LCD	X
		15" color LCD with Touch Panel	●
		640M(256KB)_500 programs	X
	Part program storage size & Number of registerable programs	1280M(512KB)_1000 programs	○
		2560M(1MB)_1000 programs	○
		5120M(2MB)_1000 programs	○
		10240M(4MB)_1000 programs	●
		20480M(8MB)_1000 programs	○
		2560M(1MB)_2000 programs	○
		5120M(2MB)_4000 programs	○
		10240M(4MB)_4000 programs	○
		20480M(8MB)_4000 programs	○

*1) The number of look-ahead blocks may be changed or limited depending on the peripheral device or the configuration of the internal NC system.



*2) Available Option only with Fanuc i plus iHMI

● Standard ○ Optional X N/A ⊕ Available
Network: FANUC MT Connect and FANUC OPC UA available.

EZ WORK

Operator convenience and work efficiency have been improved with adoption of various convenient control functions and ergonomic design.

Operating console

<p>1. 15" Color TFT LCD Monitor</p> 	<p>2. Mono Lever</p> 
<p>3. Membrane Keyboard</p> 	<p>4. Portable MPG</p>  <p>LCD Portable MPG Handle <small>option</small></p>
<p>5. Hot Key</p> 	<p>6. Swiveling Operation Panel</p> <p>The operation panel can swivel up to 80° improving user convenience.</p>

Excellent Accessibility

NX 5500 II	A	mm (inch)	815 (32)
	B	mm (inch)	265 (10)
	C	mm (inch)	860 (34)

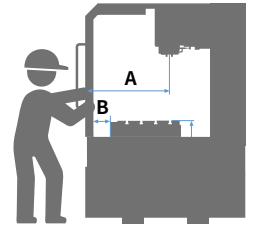

Convenient Absolute Feed

The current position of the machine is stored and maintained using battery power. Zero point return is not necessary after a power cycle.

System Condition Indicator

LED Indoor Work Light



Ez work

The EOP package delivers speed and efficiency. This menu-driven innovation not only helps customers reduce setup times, but also simplifies common tasks and procedures, reducing the potential for errors. EOP reduces operating time, protects machinery,



Tool Load Monitor

Function to automatically monitor tool load (Different loads can be set for one tool according to M700 ~ M704)



M/G-Code List

Functional description of M code and G code



Tool Management

Function to manage tool information [Tool information / Tool No. / Tool condition (normal, large diameter, worn / damaged, used for the 1st time, manual) / Tool name]



Operation Rate

Machine operation history management function by date based on load



Adaptive Feed Control

Function to control feedrate so that the cutting can be carried out at a constant load (To adapt to the spindle load set up with constant load feedrate control function)



Work Offset Setting

Work Offset을 쉽게 설정하도록 제공하는 화면



Spindle Warm Up

A function that assists spindle warm-up for spindle life when the spindle has not been used for a certain period of time



ATC Recovery

Function to view detailed info with recommended actions and to perform step-by-step operation manually (when an alarm is triggered during an ATC operation)

CONVENIENT OPERATION

HEIDENHAIN TNC640

Superior hardware specifications

The TNC 640 features optimized motion control, short block processing times and special control strategies. Together with its uniform digital design and its integrated digital drive control (including inverters), it enables you to achieve high machining speeds and the best possible contour accuracy.

- 15.6" display
- 21GB Storage memory
- 500 look ahead blocks
- High user convenience with folder structure data management



Conversational convenient function



Data are controlled in the folder structure; convenient communication via USB devices



KinematicOpt & KinematicComp option (Touch probe cycle for automatic measurement)



Collision protection system option



Adaptive feed control option



Various built-in pattern cycles for a wider scope of application (Software standard)

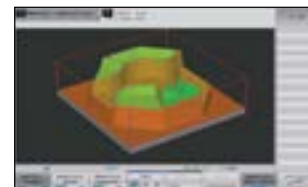

Graphic simulation

NUMERIC CONTROL SPECIFICATIONS



HEIDENHAIN

Item		Specifications	TNC640
			NX 5500 II
Controlled axis	Controlled axis		3 (X,Y,Z)
	Simultaneously controlled axis		4 axis
Data input/output	USB memory input/output		●
Interface function	Embedded ethernet		●
Feed function	Look-ahead	5000 blocks	●
Axis compensation	KinematicsOpt	Automatic measurement and optimization of machine kinematics	○
Collision monitoring	Dynamic collision monitoring (DCM)		X
Network	MTConnect		⊕
Others	Display unit	15.1 inch TFT color flat panel	●
		15.1 inch TFT color with Touch Panel	○
		19 inch TFT color flat panel	○
		19 inch TFT color with Touch Panel	○
	Part program storage size & number of registerable programs	21GB	●
	1.8GB	X	

● Standard ○ Optional X Not Available ⊕ Available

POWER | TORQUE

20000 r/min

Max. Spindle torque: **22 kW**
30 Hp

Taper : **ISO #40**

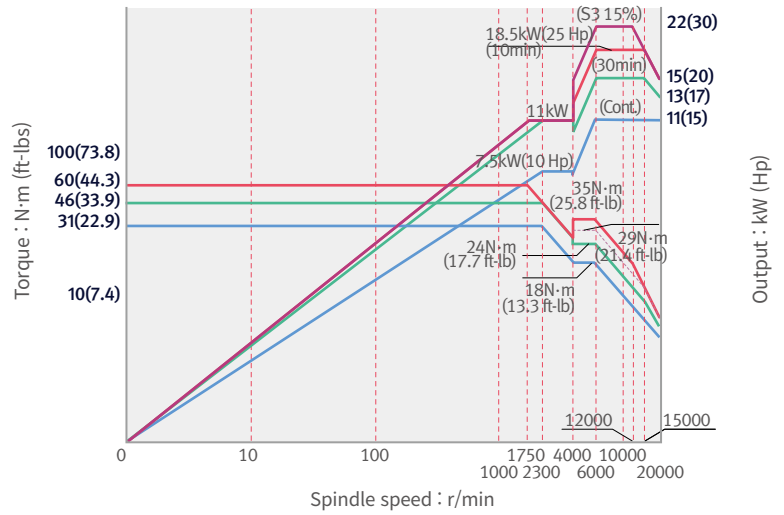

30000 r/min

Max. Spindle torque: **18.5 kW**
25 Hp

Taper : **HSK-F63** option

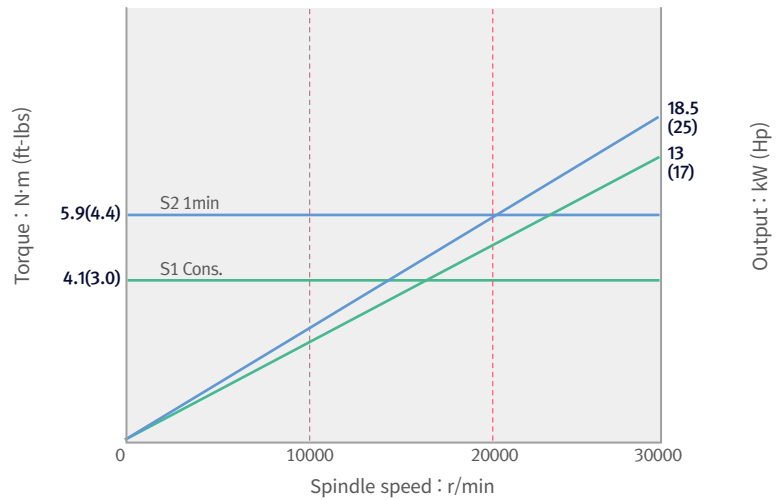

40000 r/min

Max. Spindle torque: **5.5 kW**
7 Hp

Taper : **HSK-E40** option

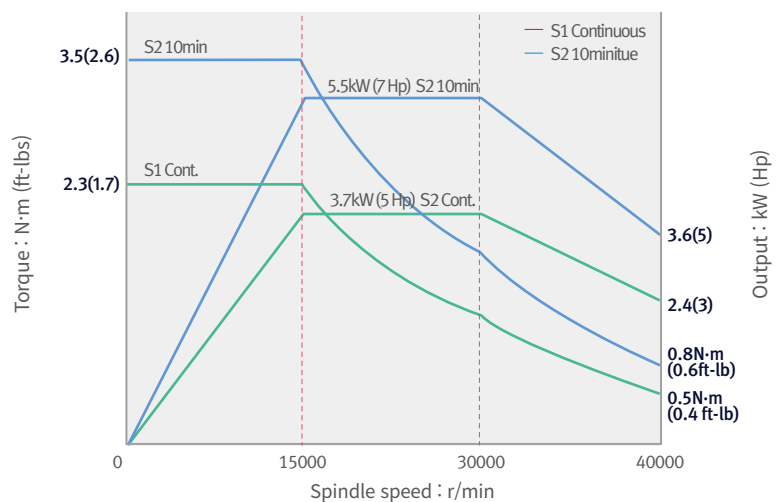

DIMENSIONS

Units : mm (inch)

TOP

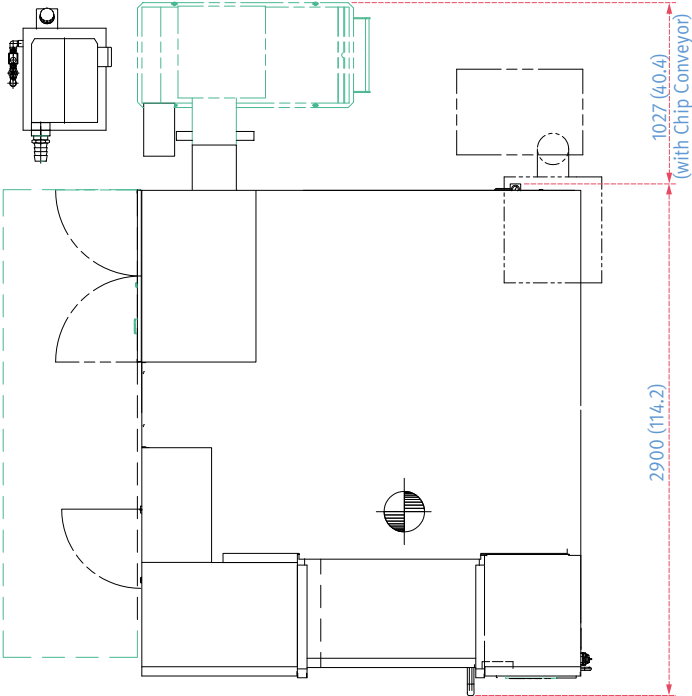

FRONT

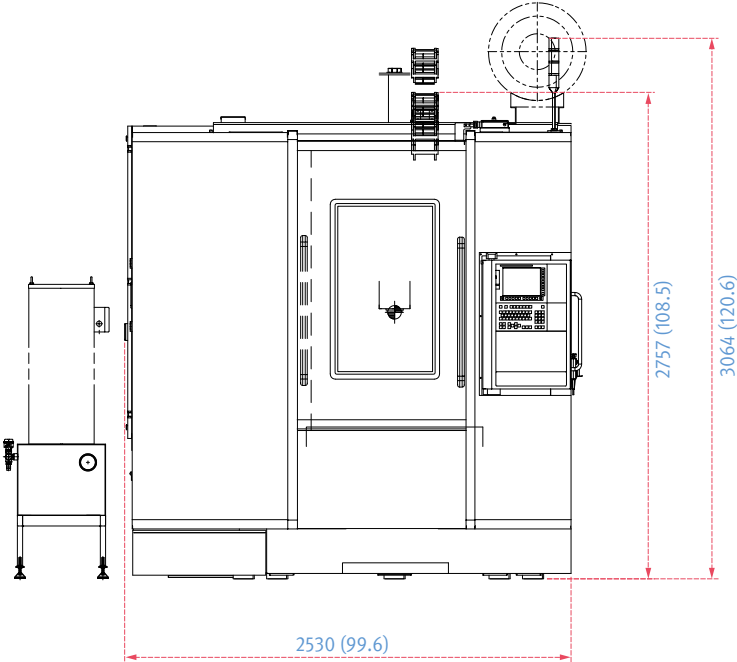
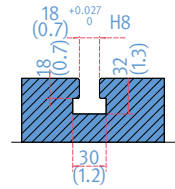
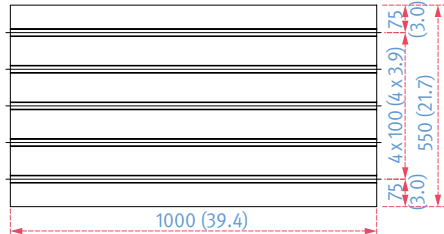

TABLE | TOOL SHANK

Table dimensions

Units : mm (inch)



Tool shank

Units : mm (inch)

20000 r/min

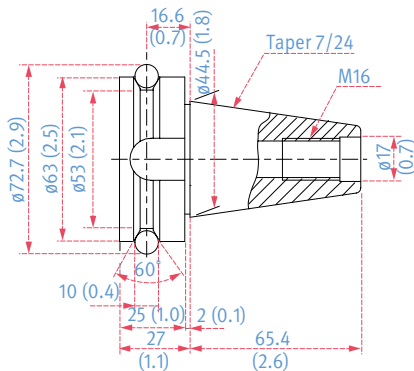

MAS 403 BT40

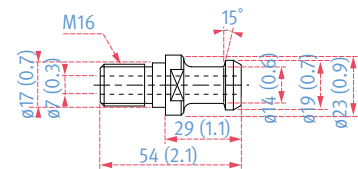

PS-806 (NIKKEN)

20000 r/min **option**

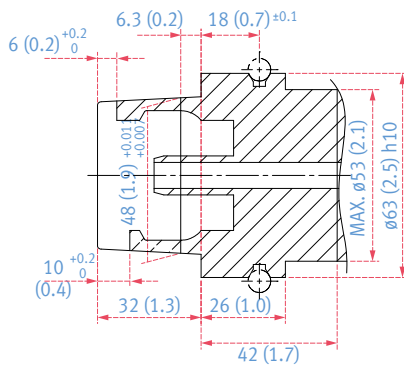

HSK A63

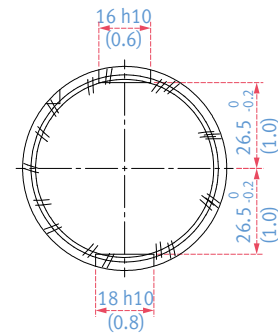

30000 r/min **option**

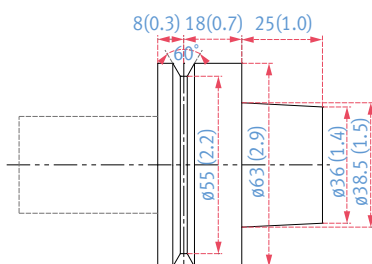

DIN 69893 HSK-F63

40000 r/min **option**

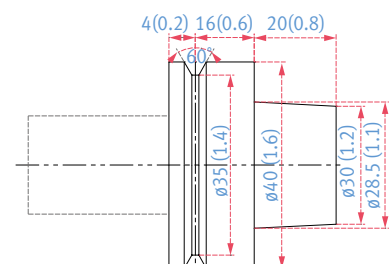

DIN 69893 HSK-E40

* Some peripheral equipment can be placed in other areas.

MACHINE SPECIFICATIONS

Item		Unit	NX 5500 II
Travels	X, Y, Z axis	mm (inch)	900 / 550 / 500 (35.4 / 21.7 / 19.7)
	Distance from spindle nose to table top	mm (inch)	150 ~ 650 (5.9 ~ 25.6)
Feedrates	Rapid traverse (X / Y / Z axis)	m/min (ipm)	30 / 30 / 30 (1181.1)
	Cutting feedrate	m/min (ipm)	15 (590.6)
Table	Table size	mm (inch)	1000 x 550 (39.4 x 21.7)
	Table loading capacity	Kg (lb)	700 (1543.2)
Spindle	Max. spindle speed	r/min	20000 {30000, 40000}*
	Spindle motor (10min/cont.)	kW (Hp)	22 / 11 (29.5 / 14.8) {18.5 / 13 (24.8 / 17.4), 5.5 / 3.7 (7.4 / 5.0)}*
	Taper spindle	Taper	ISO #40 7/24 {HSK-F63, HSK-E40}*
	Max. spindle torque (10min)	N.m (ft-lbs)	60 (44.3) {5.9, 3.5 (4.3, 2.6)}*
Automatic Tool Changer	Number of tools	ea	30
	Max. tool diameter	mm (inch)	80 (3.1)
	Max. tool diameter without adjacent tools	mm (inch)	125 (4.9)
	Max. tool length	mm (inch)	220 (8.7)
	Max. tool weight	Kg (lb)	7 (15.4)
	Max. tool moment	N · m (ft-lbs)	7.84 (5.8)
	Tool change time (tool-to-tool)	s	1.6
Power Source	Electric power supply	kVA	46.6 {43, 31}*
Tank Capacity	Coolant tank capacity	L (gal)	230 (60.8)
	Lubrication tank capacity	L (gal)	3.0 (0.8)
Machine Demensions	Length x Width	mm (inch)	2530 x 2900 (99.6 x 114.2)
	Height	mm (inch)	3064 (120.6)
	Weight	Kg (lb)	9000 (19841.3)
NC system	-	-	Fanuc 31i/32i Plus {HEIDENHAIN}*

* { } : Option

RESPONDING TO CUSTOMERS ANYTIME, ANYWHERE

DN Solutions Global Network

DN Solutions provides systems-based professional support services, before and after the machine tool sale, by responding quickly and efficiently to customers. By supplying spare parts, product training, field service and technical support, we provide the expert care, attention and assistance our customers expect from a market leader.

Global sales and service support network		51	Technical centers Technical center, Sales support, Service support, Parts support
4	Corporations	200	Service posts
156	Dealer networks	3	Factories



CUSTOMER SUPPORT AND SERVICES

We're there for you whenever you need us.

We help our customers operate at maximum efficiency by providing them with a range of tried, tested and trusted services - from pre-sales consultancy to post-sales support.



Field services

- On-site service
- Machine installation and testing
- Scheduled preventive maintenance
- Machine repair service



Parts supply

- Supplying a wide range of original DN Solutions spare parts
- Parts repair service



Training

- Programming, machine setup and operation
- Electrical and mechanical maintenance
- Applications engineering



Technical support

- Supports machining methods and technology
- Responds to technical queries
- Provides technical consultancy



dn-solutions.com

Head Office

22F T Tower, 30, Sowol-ro 2-gil
Jung-gu, Seoul, Korea, 04637

Tel: +82-2-6972-0370/0350
Fax: +82-2-6972-0400

DN Solutions America

19A Chapin Road, Pine Brook
New Jersey 07058, United States

Tel: +1-973-618-2500
Fax: +1-973-618-2501

DN Solutions Europe

Emdener Strasse 24, D-41540
Dormagen, Germany

Tel: +49-2133-5067-100
Fax: +49-2133-5067-111

DN Solutions India

No.82, Jakkuar Village
Yelahanka Hobli, Bangalore-560064

Tel: + 91-80-2205-6900
E-mail: india@dncompany.com

DN Solutions China

Room 101,201,301, Building 39 Xinzhuan
Highway No.258 Songjiang District
China Shanghai (201612)

Tel: +86 21-5445-1155
Fax: +86 21-6405-1472

Sales inquiry

sales@dncompany.com

* For more details, please contact DN Solutions.

* Specifications and information contained within this catalogue may be changed without prior notice.