



LARGE, HIGH-SPEED, HIGH-PRECISION
MACHINING CENTER

VM

750(L) • 960(L) • 1260



DN SOLUTIONS

VM series 750(L) • 960(L) • 1260

Low-vibration built-in spindle and highest stroke in its class. Designed for both roughing and finishing, the VM Series provides a product line-up ranging from Unit 7 to Unit 12 sizes. The new design boasting improved operator convenience and work efficiency will raise users' productivity and create added value.





RIGID CONSTRUCTION FOR HEAVY DUTY APPLICATIONS

- High feedrate and precision have been realized with the adoption of a stable C-type column structure and bed design.

HIGHEST RELIABILITY REALIZED WITH A WIDE RANGE OF SPINDLE SPEEDS AND EXCELLENT QUALITY

- Dual contact spindle (standard)
- Gear type 6000 rpm / 8000 rpm
- Built-in type 12000 rpm

CONTROL SOLUTION FOR PROCESSING HIGH-QUALITY MOLDS

- High-speed, high-precision contour control
- Tool monitoring
- Optimal feed control

BASIC STRUCTURE

High feedrate and precision have been realized with the adoption of a stable C-type column structure and bed design.

Rapid traverse

The adoption of a wide box guide structure delivers greater rigidity and stability. The entire upper surface of the saddle is equipped with slide bearings and oil grooves to prevent friction and wear.

Rapid traverse rate

VM 750 (L)

20 / 20 / 20 m/min
787.4 / 787.4 / 787.4 ipm

VM 960 (L)

16 / 16 / 16 m/min
629.9 / 629.9 / 629.9 ipm

VM 1260

12 / 12 / 12 m/min
472.4 / 472.4 / 472.4 ipm



Rigid construction for heavy duty applications

- The rigidity is increased by effectively arranging the box type structure of bed, column and saddle.
- The spindle head is supported by the wide guide way for the stable cutting performance.
- Wide z-side slide and wide y-side transport support prevent skewing and make it suitable for powerful, heavy cutting.

Exceptionally durable all-in-one single frame construction

The wide bed slide is heat-treated with high frequency providing outstanding performance during heavy duty cutting operations.



Radial rib structure

The processing is improved with the reduced weight and absorbed vibrations during heavy duty cutting.



Coolant recirculation system

The cleanliness and service life of the coolant have been improved.

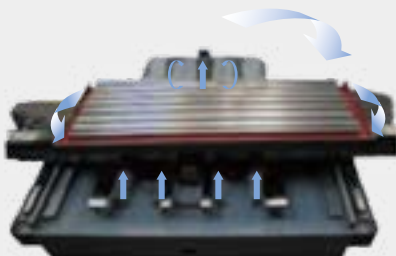

Ball screw

Large diameter ball screw for powerful cutting

Fitted with high-precision, fixed ends, pre-tensioned double anchor structure ball screw. The nut is cooled on the outer rim to minimize thermal error, while direct-coupled structure delivers rapid responsiveness and excellent rigidity.



TABLE

Basic type and long type table specifications are available in addition to diverse machining solutions.

The extended X axis travel distance allows the setting up and cutting of wider workpieces of various shapes.

Table size

VM 750 (L)

1600 x 800 (1900 x 800) mm
63.0 x 31.5 (74.8 x 31.5) inch

VM 960 (L)

2400 x 950 (2600 x 950) mm
94.5 x 37.4 (102.4 x 37.4) inch

VM 1260

2800 x 1260 mm
110.2 x 49.6 inch

Max weight on table

VM 750 (L)

3000 (3500) kg 6613.8 (7716.1) lb

VM 960 (L)

4000 (4500) kg 8818.4 (9920.7) lb

VM 1260

8000 kg 17636.7 lb

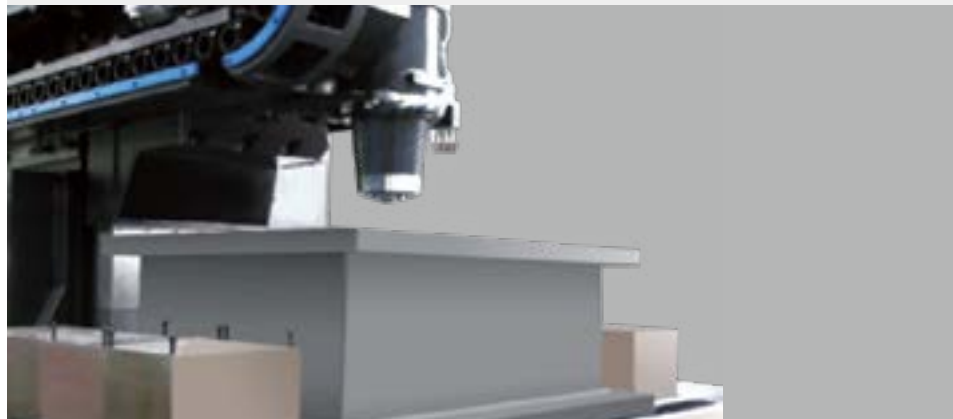

TOOL CHANGE SYSTEM

Tool to tool time (T-T-T)

2.5 sec.

Tool storage capacity

VM 750 (L) / VM 960 (L)

30 ea

40 ea option

VM 1260

40 ea

Minimized idle time

A high-speed cam-type tool changer has been adopted as a standard feature to deliver higher productivity. The loop-type magazine on the left side of the machine stores 30 tools as standard, and can be extended.



SPINDLE

The stable thermal-displacement-preventive structure minimizes spindle taper error at high speed. The wide range of speeds and excellent quality of the spindle guarantee the highest reliability.

Gear type

- Powerful cutting of large workpieces: Powerful processing capability of large workpieces with maximum torque is offered by 2-stage gear drive.
- High-speed tapping: Standard adoption of rigid tap allows high speed tapping without the tap holder.
- High rigidity and stability: Rigid angular contact bearing is adopted to assure rigidity and stability by maintaining the rigidity even during heavy duty cutting.

Max. spindle speed

6000 r/min

8000 r/min option

Motor (30 min/cont.)

VM 750 (L) / VM 960 (L)

18.5 / 15 kW 24.8 / 20.1 Hp

VM 1260

22 / 18.5 kW 29.5 / 24.8 Hp

Built-in type option

- **Rigid and precise spindle**
Adoption of 100 diameter rigid ceramic bearing and assure high precision even during the extended time of high speed rotation.
- **Highest speed spindle in its class**
Adoption of low vibration built-in motor offers optimum molding with the highest spindle speed (12000 r/min) and the highest torque of 420 N·m (310.0 ft-lb) in its class.

Max. spindle speed

12000 r/min

Motor (30 min/cont.)

30 / 25 kW 40.2 / 33.5 Hp

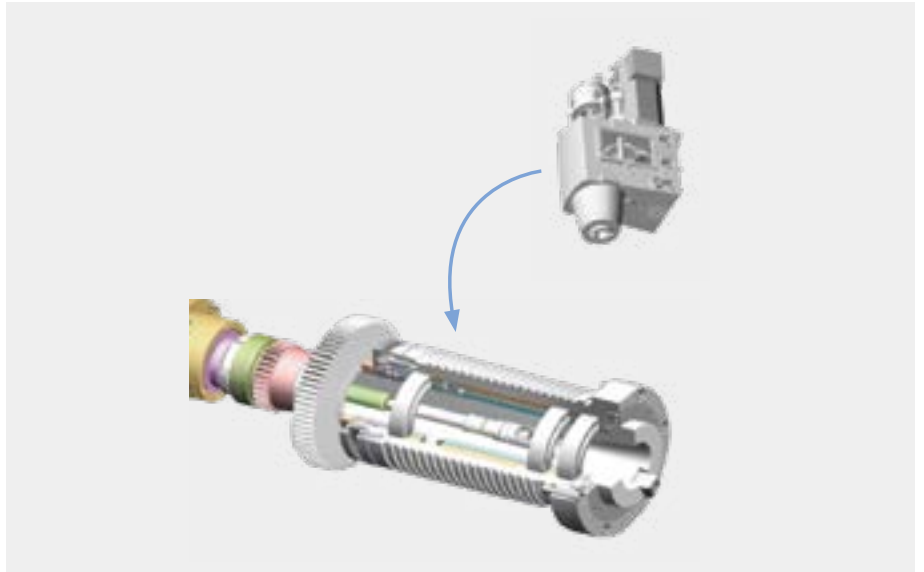

Dual contact spindle

Dual contact spindle (BIG PLUS) adopted as a standard feature

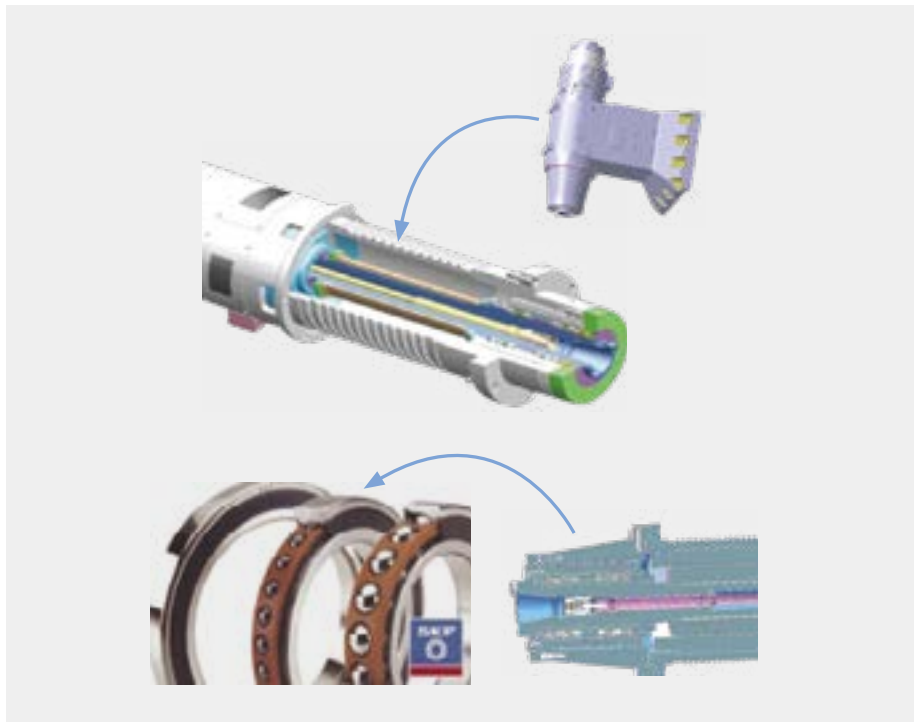
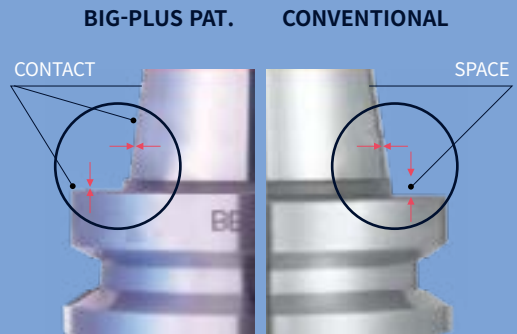

CUTTING PERFORMANCE

Provides high-productivity and high-accuracy in a variety of machining operations.

VM 1260 [12000 r/min]

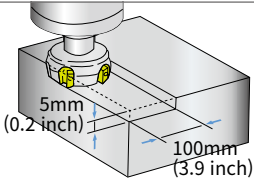
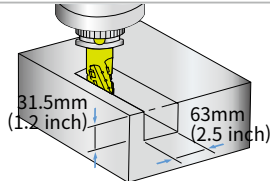
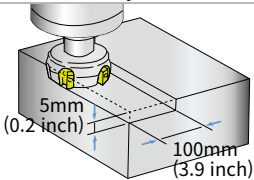
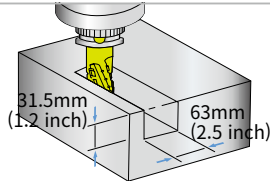
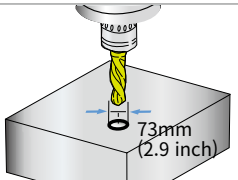
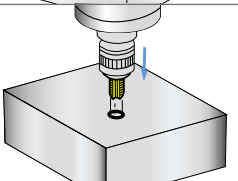
Face mill Carbon steel (SM45C) ø125mm Face mill (8Z)			
Machining rate cm ³ /min (inch ³ /min)	Spindle speed r/min	Feedrate mm/min (ipm)	
660 (40.3)	500	1660 (65.4)	
End mill Carbon steel (SM45C) ø63mm Endmill (4Z)			
Machining rate cm ³ /min (inch ³ /min)	Spindle speed r/min	Feedrate mm/min (ipm)	
635 (38.8)	500	320 (12.6)	
Face mill Gray casting (GC25) ø125mm Face mill (8Z)			
Machining rate cm ³ /min (inch ³ /min)	Spindle speed r/min	Feedrate mm/min (ipm)	
1260 (76.9)	500	2520 (99.2)	
End mill Gray casting (GC25) ø63mm Endmill (4Z)			
Machining rate cm ³ /min (inch ³ /min)	Spindle speed r/min	Feedrate mm/min (ipm)	
1012 (61.8)	1012	320 (12.6)	
Drill Carbon steel (SM45C) ø73mm Drill (2Z)			
	Spindle speed r/min	Feedrate mm/min (ipm)	
	500	140 (5.5)	
Tap Carbon steel (SM45C) ø73mm Drill (2Z)			
	Tool	Spindle speed r/min	
	M42 x P4.5	400	

* The results, indicated in this catalogue are provides as example. They may not be obtained due to differences in cutting conditions and environmental conditions during measurement.

Machining accuracy

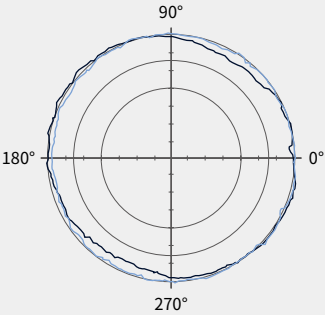
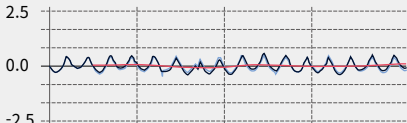
Roundness 8.2 µm 		Roughness Ra 0.22 µm 	
Model	VM 750 (L) / 960 (L) / 1260	Spindle Speed	6000 r/min
Material	Al6061	Feedrate	900 mm/min (35.4 ipm)
Tool	ø10mm (0.4 inch) (Endmill : 3Z)		

* The results, indicated in this catalogue are provides as example. They may not be obtained due to differences in cutting conditions and environmental conditions during measurement.

OPTIMIZED TOOL PROCESSING SOLUTION

Superior surface finishes and superior machining precision are achieved by using standard DN Solutions processing solutions, such as high speed / high precision contour control and thermal displacement compensation functions.

High Speed / High Precision Contour Control

- **DSQ1** (AICC2 _ 200 Block + Machining condition selection function)
- **DSQ2** option (DSQ1 + Data server [1GB])
- **DSQ3** option (DSQ2 + High speed processing _ 600 Block)



*DSQ : DN Solutions Super Quality

Tool Load Monitoring System (DTMM*)

The technology that protects the tool and machine when machining abnormal loads.

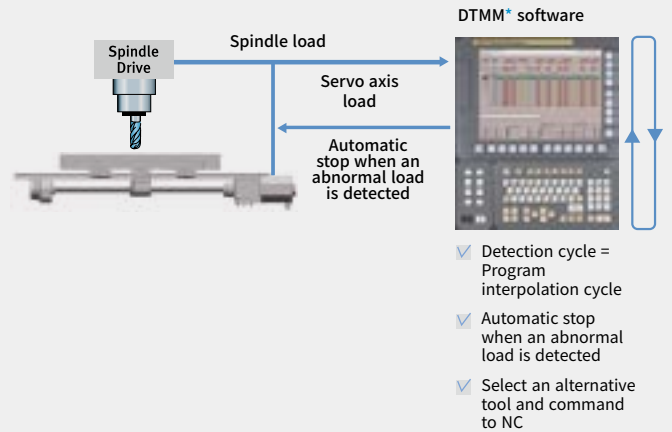

*DTMM : DN Solutions Tool load Monitoring for Machining Centers

The Optimal Feed Control (DAFC*)

Optimal feed control is ensured by spindle load detection that occurs in real time.

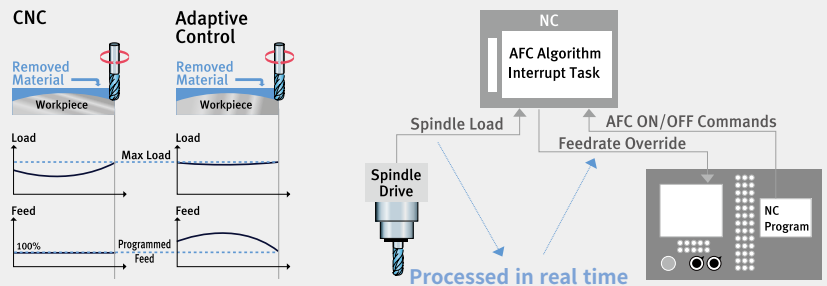

*DAFC : DN Solutions Adaptive Feedrate Control

Smart, multi-compensation thermal displacement technology

Realization of high-quality, high-precision machining achieved by thermal compensation of the spindle and machine structure.

Compensation of static spindle displacement

Compensates for changes in tool position caused by expansion of the spindle shaft during high speed operations.

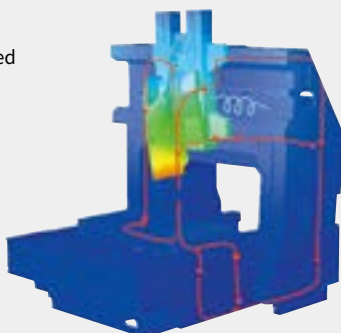

Structural thermal displacement compensation

Compensates for any irregular deflection or expansion of the structure due to ambient temperature fluctuation by using multiple temperature sensors.

Thermal displacement compensation structure

Thermal displacement of the spindle, caused by heat accumulation, is compensated for using 5 algorithms including a smoothing function.

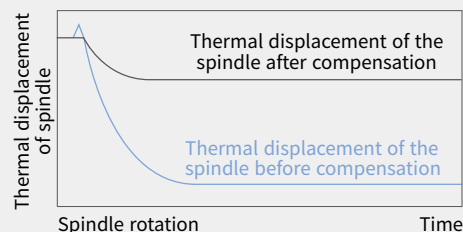
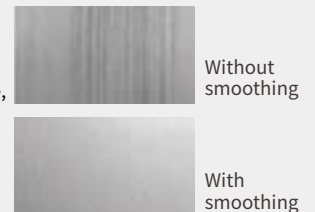

*DSTC : DN Solutions Smart Thermal Control

STANDARD | OPTIONAL SPECIFICATIONS

A range of options is available to suit individual requirements.

Description	Features	VM750 (L)	VM960 (L)	VM1260			
Spindle	6000 r/min	18.5/15 kW, 587.4 N·m	●	●	X		
		22/18.5 kW, 698.8 N·m	○	○	●		
		26/22 kW, 825.9 N·m	○	○	○		
	8000 r/min	18.5/15 kW, 587.4 N·m	○	○	X		
		22/18.5 kW, 698.8 N·m	○	○	○		
		26/22 kW, 825.9 N·m	○	○	○		
12000 r/min	30/25 kW, 420 N·m	○	○	○			
Magazine	Tool storage capacity	30 ea	●	●	X		
		40 ea	○	○	●		
Tool shank type	BIG PLUS BT50	45°	●	●	●		
		60°	○	○	○		
	BIG PLUS CAT50	45°	○	○	○		
		60°	○	○	○		
	BIG PLUS DIN50		○	○	○		
Coolant	FLOOD	0.15 MPa (0.4 kW)	●	●	●		
		0.1 MPa (1.1 kW)	○	○	○		
	TSC	None	●	●	●		
		2 MPa (1.5kW)	○	○	○		
		2 MPa (4 kW)	○	○	○		
		7 MPa (5.5 kW)	○	○	○		
	Shower coolant		○	○	○		
CHIP PAN		●	●	●			
Chip disposal	Conveyor	Hinged Belt Type Conveyor_Rear Side	○	○	○		
		Hinged Belt Type Conveyor_Front Side	○	○	○		
	Bucket	Fork Lift Type / 300	○	○	○		
		Rotation Type / 300	○	○	○		
Air blower		●	●	●			
Coolant gun		○	○	○			
Precision machining option	Linear scale	X / Y / Z axis	○	○	○		
		DSQ 1 (200 block)	●	●	●		
		DSQ 2 (DSQ 1, DATA SERVER 1G)	○	○	○		
		DSQ 3 (DSQ 2, 600 block)	○	○	○		
		DSQ 4 (DSQ 3, 1000 block)	○	○	○		
MPG	1 MPG_Display Type		○	○	○		
		1 MPG_Portable Type	○	○	○		
		1 MPG_Portable_with Enable Type	○	○	○		
		3 MPG_Portable Type	●	●	●		
		3 MPG_Portable_with Enable Type	○	○	○		
		3 MPG_Stand Type	○	○	○		
Others	3 Color signal tower		●	●	●		
			●	●	●		
		EZ Guide i	○	○	○		
Accessories	Work Light	LED Lamp	●	●	●		
		Operator Call Lamp	●	●	●		
		Leveling Block & Bolt	●	●	●		
		Smart Thermal Control	Sensor Type (Spindle & Structure)	●	●	●	
		Air Blower		●	●	●	
		Assembly & Operaion Tools Kit		●	●	●	
		Auto Tool Length Measurement	Maker/SPEC.	Renishaw / OMP60	○	○	○
				Renishaw / TS27R	○	○	○
		Step Foot Stool		○	○	○	
		Calibration Block		○	○	○	
		Machine Lifting Hooks		○	○	○	
		Mist Collector	2.2 KW_Water Soluble		○	○	○
				2.2 KW_None Water Soluble	○	○	○
		Test Bar Gauge		○	○	○	
		Air Gun		○	○	○	
		Customized special option	Coolant level switch : Sensing level - Low / High	ATC Auto Shutter	○	○	○
				Raising Blocks	200mm	○	○
ATC Auto Shutter	300mm			○	○	○	
Magnetic Scraper Type Conveyor				○	○	○	
Anchoring ¹⁾	J-BOLT			○	○	X	
Coolant Chiller ²⁾				○	○	○	
Auto Tool Length Measurement	Maker/SPEC.			Renishaw / NC4	○	○	○
				OMRON / D5A	○	○	○
Auto Tool Breakage Detection	Needle			○	○	○	
4th axis Preparation Cabling for Servo /1-Pneumatic Piping				○	○	○	
4th axis with CNC R.Table ³⁾	Available Size			Ø500mm	○	○	○
				Servo Motor	Depends on the table	○	○
5th axis ³⁾	Available Size	Usee Defined	○	○	○		
		Servo Motor		○	○	○	

*Please contact DN Solutions for detailed specifications.

● Standard ○ Optional x Not applicable

1) PLEASE REFER TO FOUNDATION DRAWING IN RELATION TO ANCHORING. IF MORE DETAIL INFORMATION WANT, CONSULT WITH DN Solutions SERVICE.

2) IN CASE OF USING NEAT CUTTING OIL, THIS DEVICE IS HIGHLY RECOMMENDED IN ORDER TO REDUCE THE CHANGE OF ACCURACY BY RISING THE COOLANT TEMPERATURE.

3) PLEASE INQUIRE DN Solutions R&D DEPARTMENT WHEN END-USER SELECT.

 **Fire Safety Precautions** | There is a high risk of fire when using non-water-soluble cutting fluids, processing flammable materials, neglecting the controlled and careful use of coolants and modifying the machine without the consent of the manufacturer. Always check the SAFETY GUIDELINES carefully before using the machine.

PERIPHERAL EQUIPMENT

Interface for Additional Axis

- Recommended rotary table size
: VM 750 (L) : $\phi 320$ mm /
VM 960 (L) : $\phi 500$ mm
VM 1260 : $\phi 500$ mm
- Please check the driving system (hydraulic or pneumatic) of the rotary table before ordering the machine.

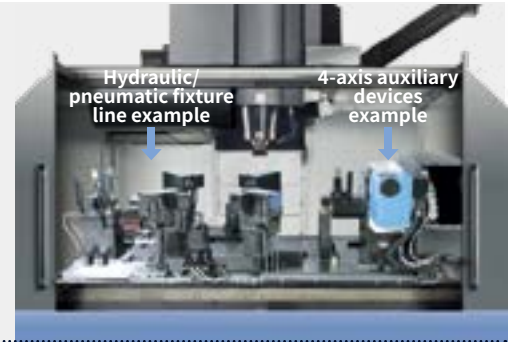

Fixture check list (for hydraulic / pneumatic fixtures)

- Pressure source
 - Hydraulic P/T A/B
 - Pneumatic P/T A/B
- Hydraulic power unit
 - Supply scope : End user DN Solutions
 - DN Solutions standard unit 24L / min, 4.9 MPa
 - Other requirements _____ L / min, _____ MPa
- Number of ports
 - 1pair (2-PT 3/8"port)
 - 2pair (4-PT 3/8"port)
 - 3pair (6-PT 3/8"port)

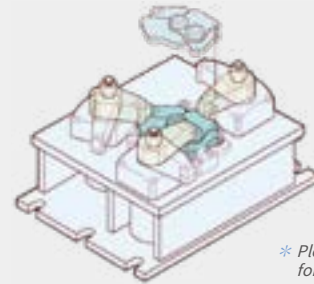

* Please contact DN Solutions for more information.

Easy Chip Disposal



Built-in spiral-type coil conveyor at front and rear of the machine (Full Cover)

Lift chip conveyor for fast chip disposal option

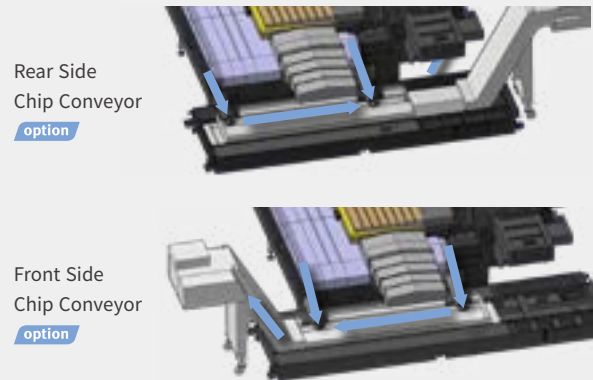

Diverse Options

Numerous options are offered for greater efficiency and customer convenience.



Coolant Gun

Coolant gun helps keeping the work environment clean.



Through-spindle coolant spray system

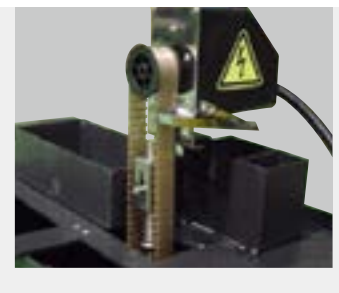

Oil skimmer

FANUC 31i/32i PLUS

Fanuc 31i/32i Plus maximizes customer productivity and convenience.

15" Touch screen + New OP

DN Solutions Fanuc 31iB/B5 Plus' operation panel enhances operating convenience by incorporating common-design buttons and layout. It features a Qwerty keyboard for fast and easy data input and operation.

Fanuc 31i/32i Plus

- 15-inch color display
- Intuitive and user-friendly design

USB and PCMCIA card QWERTY keyboard

- EZ-Guide i standard
- Ergonomic operator panel
- 4MB Memory
- Hot keys
- Enhance AICC BLOCK
- Touch pen provided as standard



iHMI touchscreen

iHMI provides an intuitive interface that uses a touchscreen for quick and easy operation.

Range of applications

Providing various applications related to planning, machining, improvement and utility, for customer convenience.

NUMERIC CONTROL SPECIFICATIONS

FANUC

Item	Specifications	F32iB Plus	
		VM series (750/960/1260)	
Controlled axis	Controlled axes	5 (X,Y,Z)	
	Simultaneously controlled axes	5 axes	
Data input/output	Additional controlled Axis	●	
	Fast data server	○	
	Memory card input/output	●	
	USB memory input/output	●	
	Large capacity memory(2GB)*2	○	
Interface function	Embedded Ethernet	●	
	Fast Ethernet	○	
	Enhanced Embedded Ethernet function	●	
Operation	DNC operation	Included in RS232C interface. ●	
	DNC operation with memory card	●	
Program input	Workpiece coordinate system	G52 - G59 ●	
	Addition of workpiece coordinate system	G54.1 P1 X 48 (48 pairs) ●	
	Tool number command	T4 digits	
Feed function	Tilted working plane indexing command	G68.2 TWP X	
	AI contour control I	G5.1 Q_, 40 Blocks X	
	AI contour control II	G5.1 Q_, 200 Blocks X	
	AI contour control II	G5.1 Q_, 600 Blocks ●	
	AI contour control II	G5.1 Q_, 1000 Blocks *1) X	
Operation guidance function	High smooth TCP	X	
	EZ Guidei (Conversational Programming Solution)	●	
	iHMI with Machining Cycle	Only with 15" Touch LCD standard *2) X	
Setting and display	EZ Operation package	●	
	CNC screen dual display function	●	
Network	FANUC MTConnect	⊕	
	FANUC OPC UA	⊕	
Others	Display unit	10.4" color LCD	X
		15" color LCD	X
	Part program storage size & Number of registerable programs	15" color LCD with Touch Panel	●
		640M(256KB)_500 programs	X
		1280M(512KB)_1000 programs	○
		2560M(1MB)_1000 programs	○
		5120M(2MB)_1000 programs	○
		10240M(4MB)_1000 programs	●
		20480M(8MB)_1000 programs	○
		2560M(1MB)_2000 programs	○
		5120M(2MB)_4000 programs	○
		10240M(4MB)_4000 programs	○
20480M(8MB)_4000 programs	○		

*1) The number of look-ahead blocks may be changed or limited depending on the peripheral device or the configuration of the internal NC system.

*2) Available Option only with Fanuc i plus iHMI

● Standard ○ Optional X N/A ⊕ Available
Network: FANUC MT Connect and FANUC OPC UA available.

EZ WORK

The software developed by DN Solutions features numerous functions designed for convenience and ease of operation.

EZ work

The EZ work delivers speed and efficiency. This menu-driven innovation not only helps customers reduce setup times, but also simplifies common tasks and procedures, reducing the potential for errors. EZ work reduces operating time, protects machinery, enhances quality and speeds up maintenance interventions.



Tool Load Monitor

Function to automatically monitor tool load (Different loads can be set for one tool according to M700 ~ M704)



M/G-Code List

Functional description of M code and G code



Tool Management

Function to manage tool information [Tool information / Tool No. / Tool condition (normal, large diameter, worn / damaged, used for the first time, manual) / Tool name]



Operation Rate

Machine operation history management function by date based on load



Adaptive Feed Control

Function to control feedrate so that the cutting can be carried out at a constant load (To adapt to the spindle load set up with constant load feedrate control function)



Spindle Warm Up

A function that assists spindle warm-up for spindle life when the spindle has not been used for a certain period of time



ATC Recovery

Function to view detailed info with recommended actions and to perform step-by-step operation manually (when an alarm is triggered during an ATC operation)

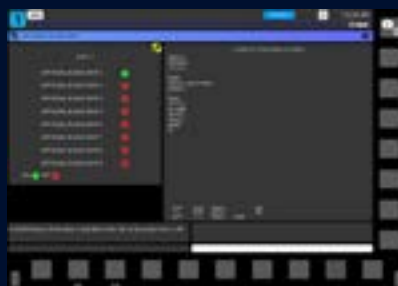

Addition of Optional Block Skip

In addition to the OPTIONAL BLOCK SKIP of the operation panel, the function to skip a specific block selected in the machining program

POWER | TORQUE

Gear type

VM 750 (L), VM 960 (L)

Max. spindle speed : 6000 r/min
Spindle motor : 18.5/15 kW (24.8/20.1 Hp) (30min./ Cont.)

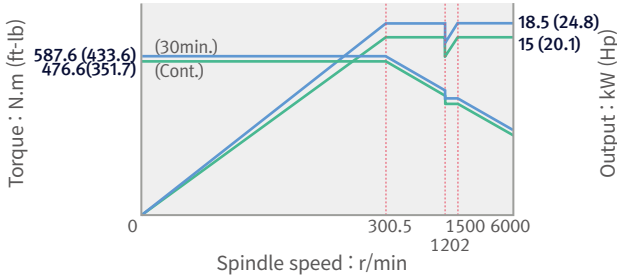

VM 750 (L) option, VM 960 (L) option

Max. spindle speed : 8000 r/min
Spindle motor : 18.5/15 kW (24.8/20.1 Hp) (30min./ Cont.)

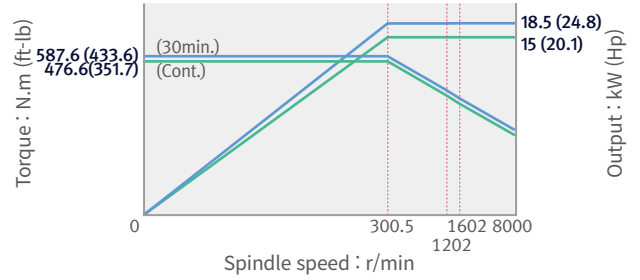

VM 750 (L) option, VM 960 (L) option, VM 1260

Max. spindle speed : 6000 r/min
Spindle motor : 22/18.5 kW (29.5/24.8 Hp) (30min./Cont)

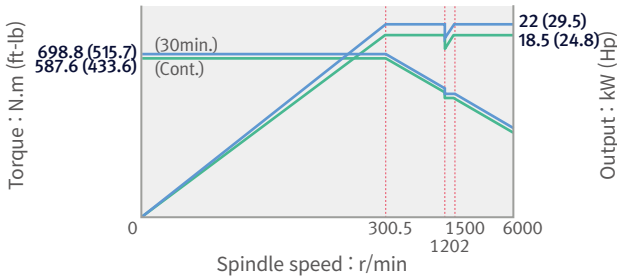

VM 750 (L) option, VM 960 (L) option, VM 1260 option

Max. spindle speed : 8000 r/min
Spindle motor : 22/18.5 kW (29.5/24.8 Hp) (30min./Cont)

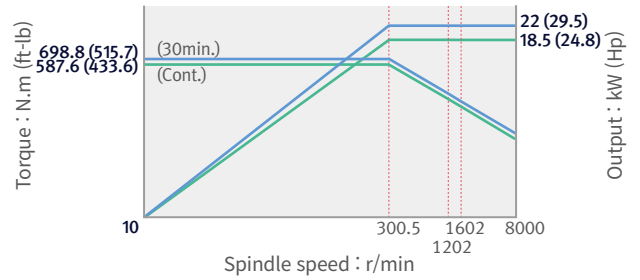

VM 750 (L) option, VM 960 (L) option, VM 1260 option

Max. spindle speed : 6000 r/min
Spindle motor : 26/22 kW (34.9/29.5 Hp) (30min./Cont.)

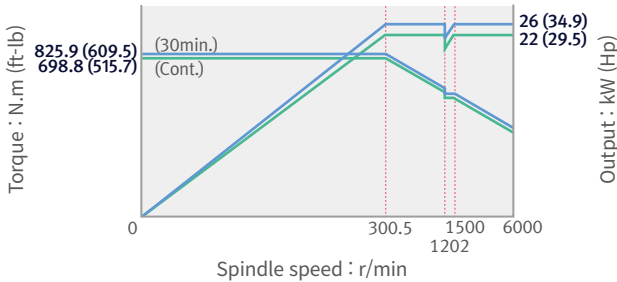

VM 750 (L) option, VM 960 (L) option, VM 1260 option

Max. spindle speed : 8000 r/min
Spindle motor : 26/22 kW (34.9/29.5 Hp) (30min./Cont.)

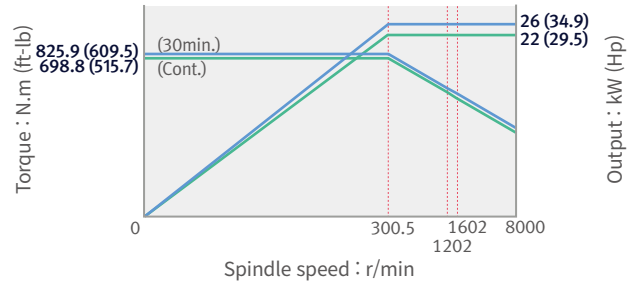

Built-in type

VM 750 (L) option, VM 960 (L) option, VM 1260 option

Max. spindle speed : 12000 r/min
Spindle motor : 30/25 kW (40.2/33.5 Hp) (30min./ Cont.)

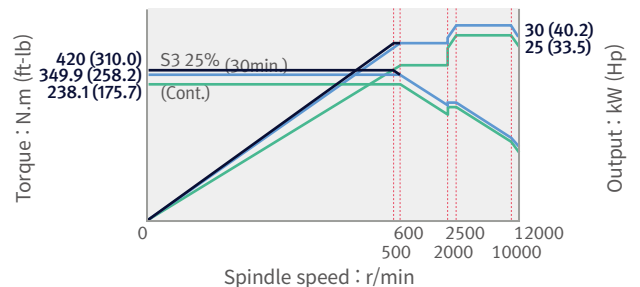

DIMENSIONS

VM 750 / 750L (HALF COVER, FOR KOREA MARKET)

Units : mm (inch)

TOP

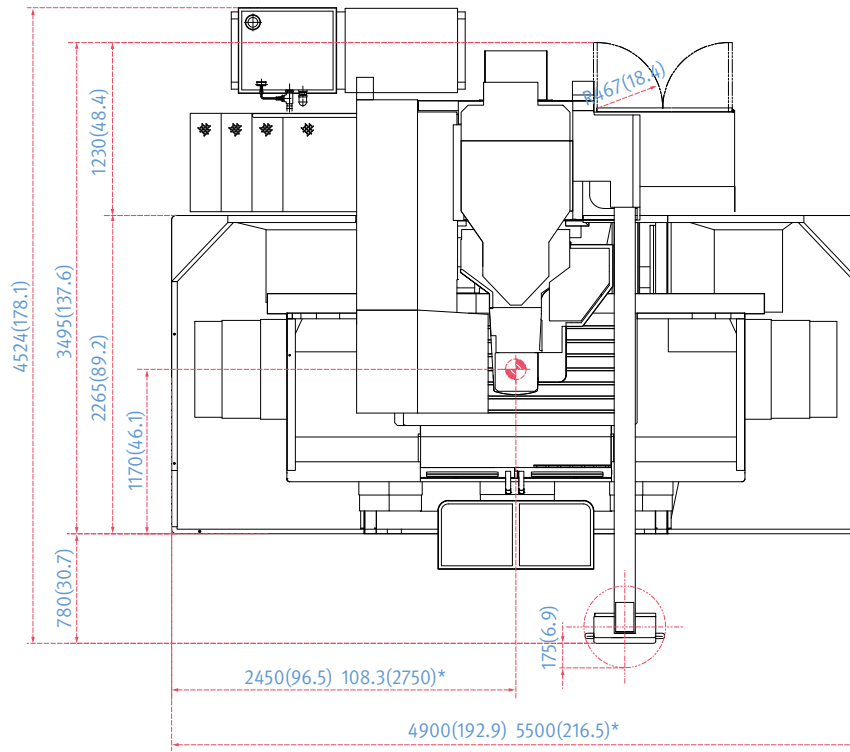

FRONT

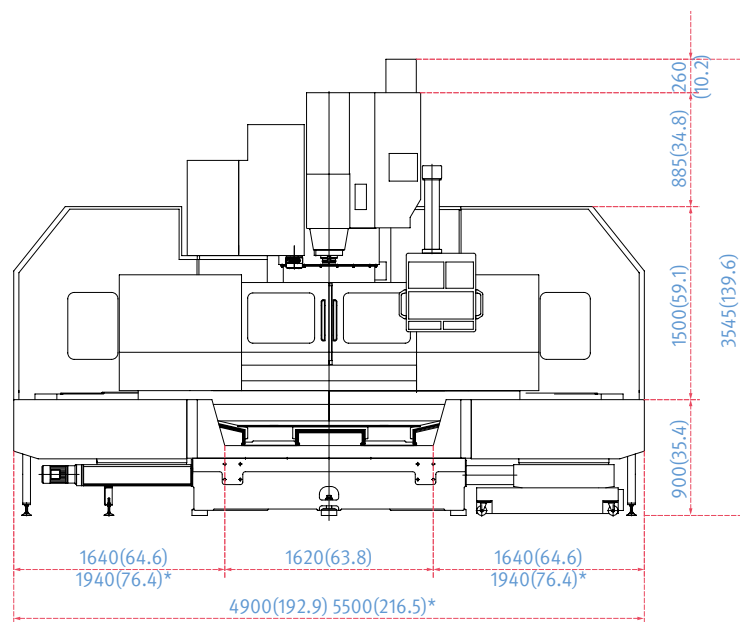

* : VM 750L

DIMENSIONS

VM 750 / 750L (FULL COVER, FOR GLOBAL MARKET) option

Units : mm (inch)

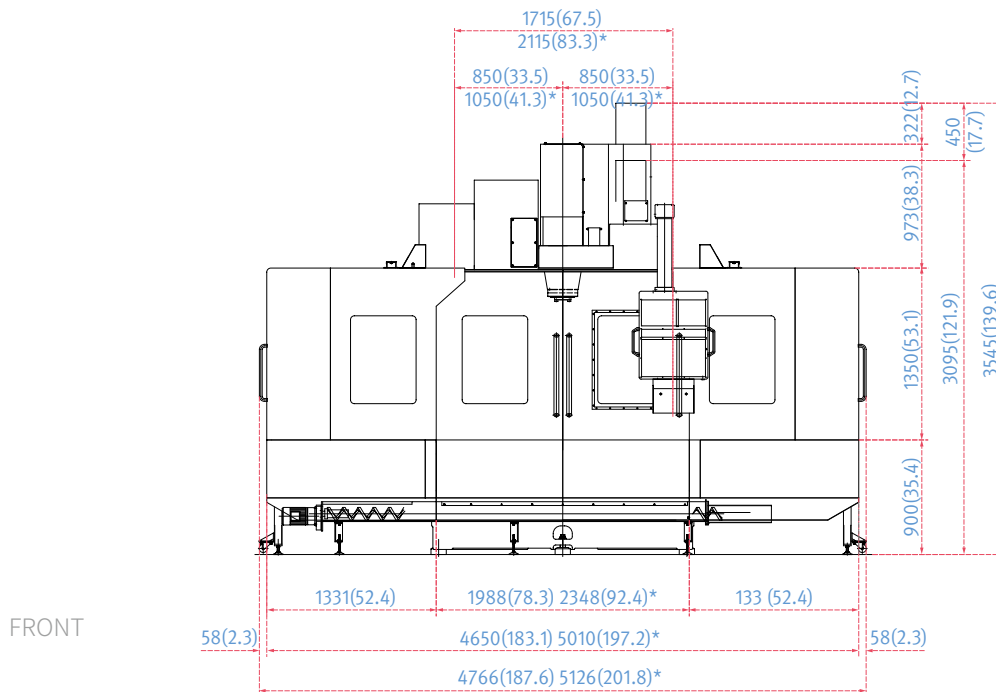
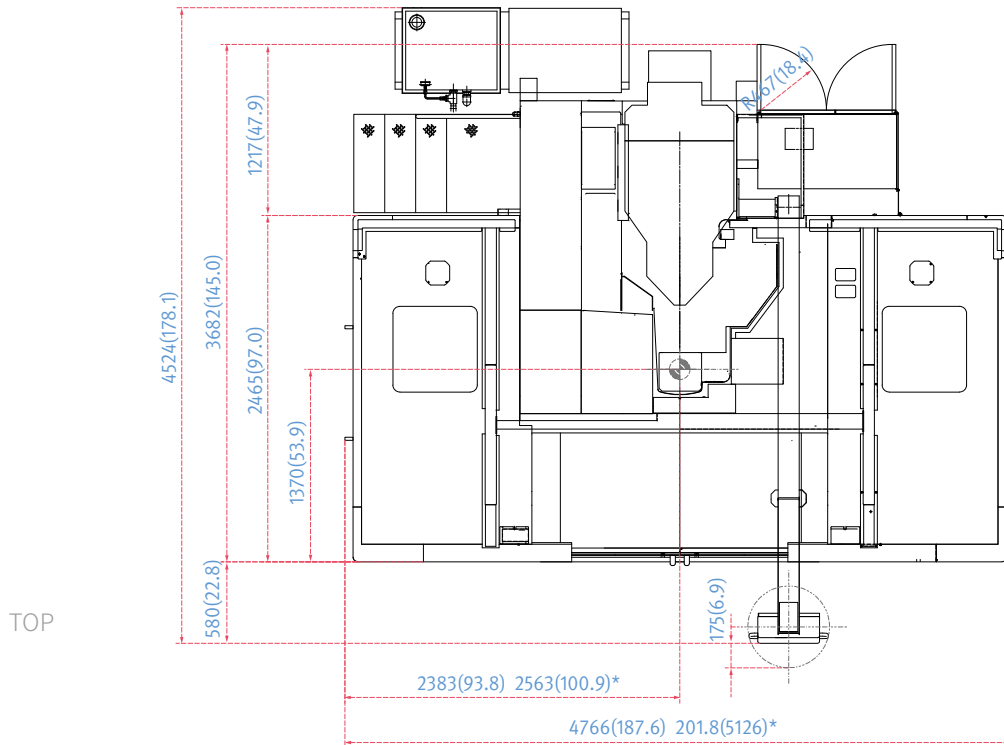

* : VM 750L

* Some peripheral equipment can be placed in other areas.

DIMENSIONS

VM 960 / 960L (HALF COVER, FOR KOREA MARKET)

Units : mm (inch)

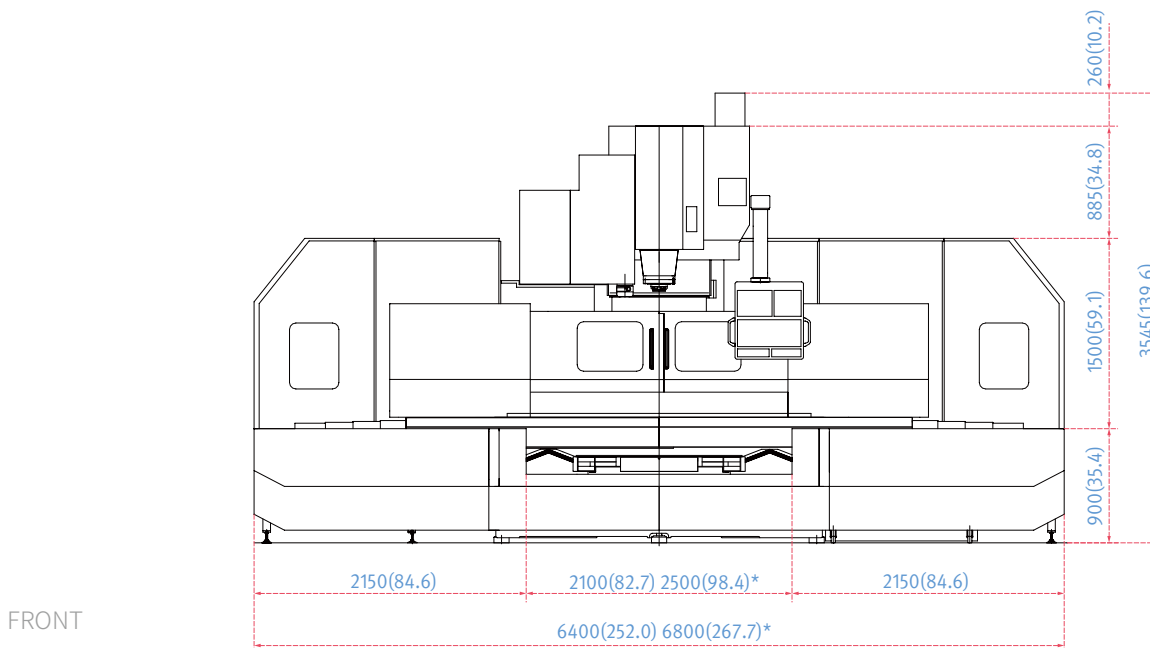
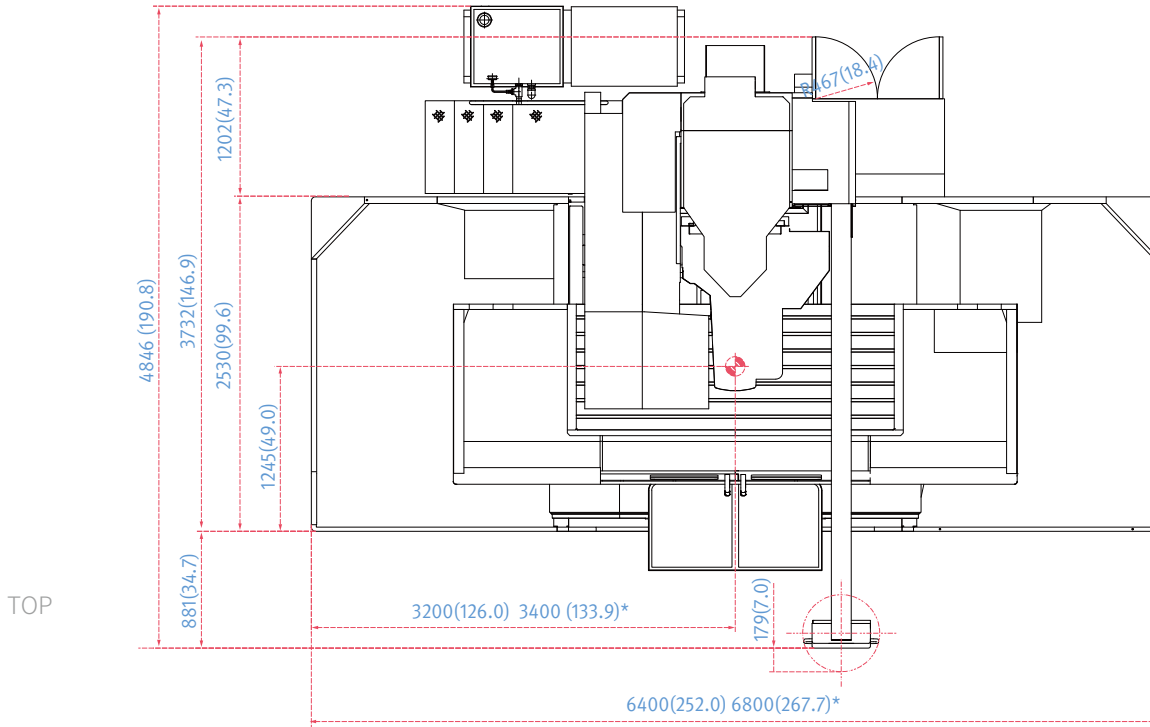

* : VM 960L

DIMENSIONS

VM 960 / 960L (FULL COVER, FOR GLOBAL MARKET) option

Units : mm (inch)

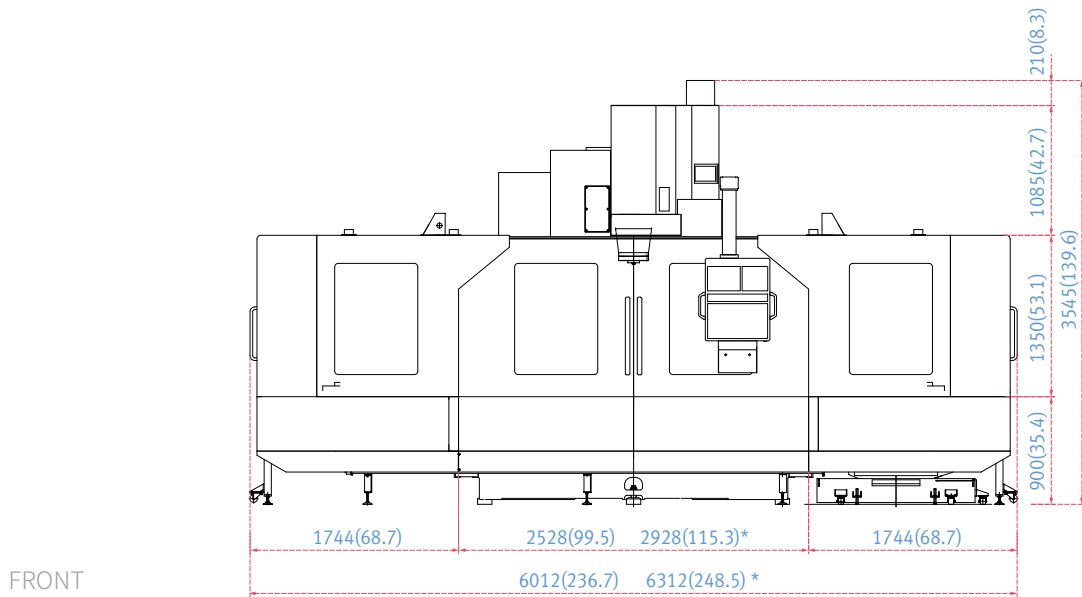
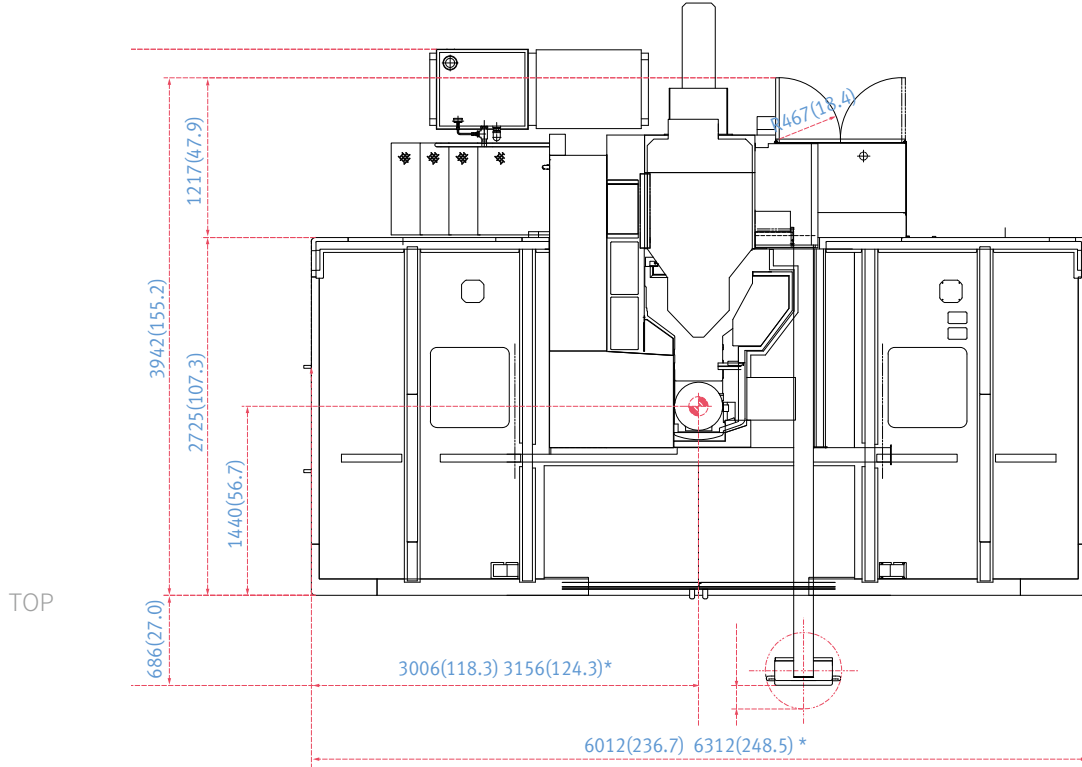

* : VM 960L

* Some peripheral equipment can be placed in other areas.

DIMENSIONS

VM 1260 (FULL COVER, FOR GLOBAL MARKET)

Units : mm (inch)

TOP

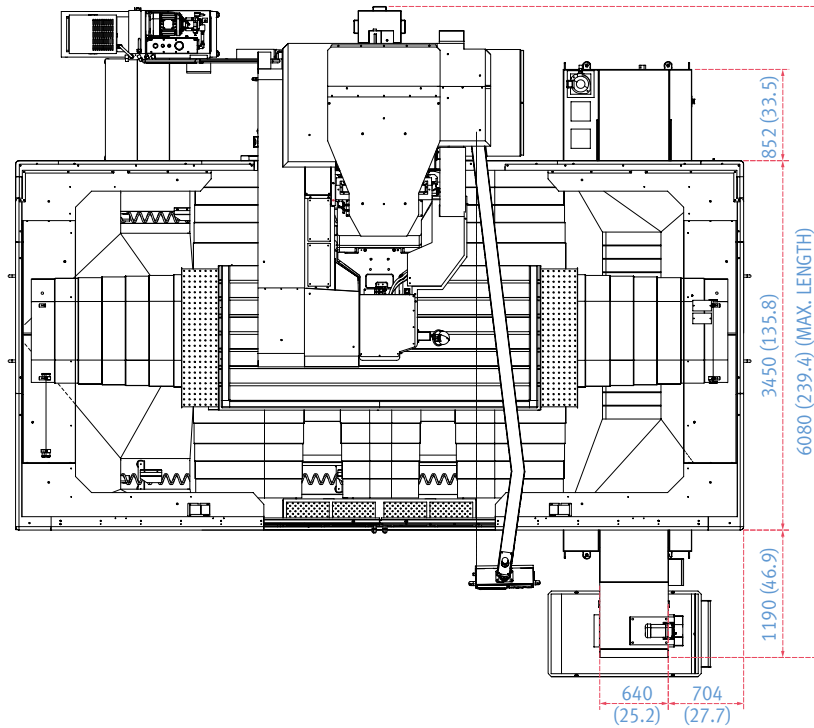

FRONT

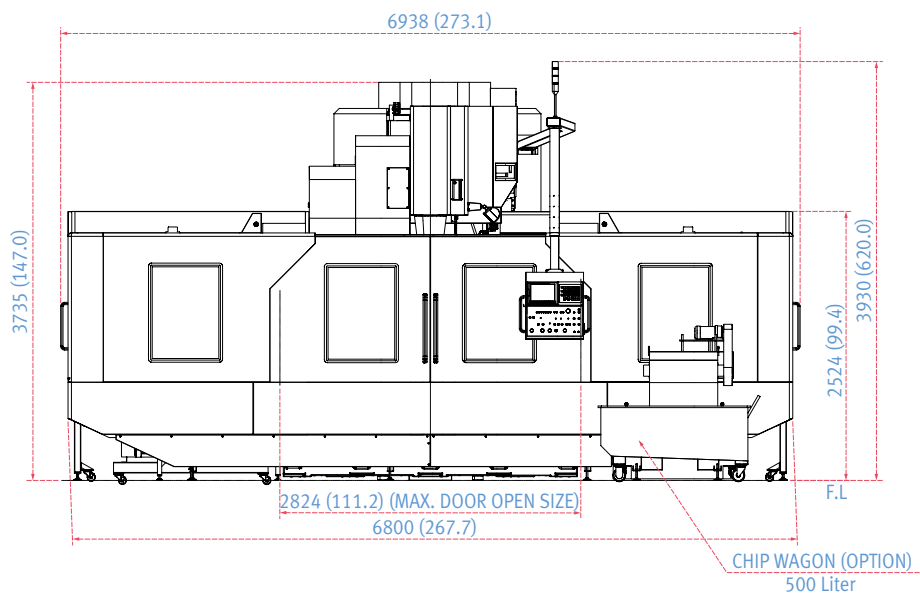

MACHINE SPECIFICATIONS

Description		Unit	VM750	VM 750L	VM 960	VM 960L	VM 1260
Travel	X-axis	mm (inch)	1500 (59.1)	1800 (70.9)	2000 (78.7)	2400 (94.5)	2500 (98.4)
	Y-axis	mm (inch)	750 (29.5)		960 (37.8)		1260 (49.6)
	Z-axis	mm (inch)	800 (31.5)				900 (35.4)
	Distance from spindle nose to table top	mm (inch)	200 - 1000 (7.9 - 39.4)				200 - 1100 (7.9 - 43.3)
	Distance from spindle nose to column	mm (inch)	865 (34.1)		1005 (39.6)		1320 (52.0)
Feedrate	Rapid feedrate (X, Y, Z)	m/min (ipm)	20 / 20 / 20 (787.4 / 787.4 / 787.4)		16 / 16 / 16 (629.9 / 629.9 / 629.9)		12 / 12 / 12 (472.4 / 472.4 / 472.4)
	Cutting feedrate	mm/min (ipm)	10000		8000		6000
Table	Table size	mm (inch)	1600 x 800 (63.0 x 31.5)	1900 x 800 (74.8 x 31.5)	2400 x 950 (94.5 x 37.4)	2600 x 950 (102.4 x 37.4)	2800 x 1260 (110.2 x 49.6)
	Loading capacity	kg (lb)	3000	3500	4000	4500	8000
Spindle	Max. spindle speed	r/min	6000 {8000, 12000}				
	Taper		ISO#50 7/24 Taper				
	Max. torque	N·m (ft-lb)	587.6 {698.8, 793.8}, {420}				698.8 {793.8}, {420}
ATC	Type of tool shank		BIG PLUS MAS403 BT50				
	Tool storage capacity	ea	30 {40}				40
	Max. tool diameter	mm (inch)	ø125 (ø4.9)				
	Max. tool dia. (when a nearest port is empty)	mm (inch)	ø230 (ø9.1)				
	Max. tool length	mm (inch)	350 (13.8)w				
	Max. tool weight	kg (lb)	15 (33.1)				
	Max. tool moment	N·m (ft-lbs)	12.74 (9.4)				
	Tool selection type		Memory Random				
	Tool change time (tool to tool)	s	2.5				
Tool change time (chip to chip)	s	6		8			
Motor	Spindle motor power (30 min)	kW (Hp)	18.5/15 {22/18.5, 26/22, 30/25} (24.8/20.1 {29.5/24.8, 34.9/29.5, 40.2/33.5})				59.39 {60, 68.33, 70} (79.6 {80.5, 91.6, 93.9})
	Travel motor (X / Y / Z)	kW (Hp)	7 / 7 / 7 (9.4 / 9.4 / 9.4)				9 / 9 / 7 (12.1 / 12.1 / 9.4)
Power Consumption	Electric power	15/18.5 (30 min)	kVA	59.39		-	
		18.5/22 (30 min)		{60}		64.95	
		22/26 (30 min)		{68.33}		{69.42}	
		25/30 (30 min)		{70}		{70}	
	Compressed air pressure	Mpa (psi)	0.54 (78.3)				
Tank Capacity	Coolant tank capacity	L	480		520		800
	Lubricant tank capacity	L	12				
Machine Size	Height (H)	mm (inch)	3545 (139.6)				3930 (154.7)
	Dimension (L x W)	mm (inch)	4524 x 4900 {4524 x 4766} (178.1 x 192.9 {178.1 x 187.6})	4524 x 5500 {4524 x 5126} (178.1 x 216.5 {178.1 x 201.8})	4846 x 6400 {4846 x 6012} (190.8 x 252.0 {190.8 x 236.7})	4846 x 6800 {4846 x 6312} (190.8 x 267.7 {190.8 x 248.5})	5645 x 6938 (222.2 x 273.1)
	Weight	kg (lb)	14000 (30864.3)	14800 (32627.9)	20000 (44091.8)	21000 (46296.4)	31000 (68342.3)

{ } : Option

WHY DN SOLUTIONS

The DN Solutions promise, MACHINE GREATNESS, has two important meanings. The first is simple: DN Solutions makes great machines. The second is a challenge to our end-users. With a product line that is this comprehensive, accurate and reliable, we equip our customers to machine greatness. The big question: *Why should you choose DN Solutions over other options?*

Here's why...



**MACHINE
GREATNESS™**



WHAT YOU MAKE AND HOW YOU MAKE IT MATTERS—SO MAKE IT
GREAT WITH DN SOLUTIONS.

UNBEATABLE MACHINES

You won't find a more comprehensive range or a better combination of value, performance and reliability anywhere else.

ROBUST PRODUCT LINE

We offer an impressive range of machine models and hundreds of configurations. Whatever your machining needs and requirements, there's a DN Solutions for you.

READILY AVAILABLE - ANYWHERE IN THE WORLD

Machining centres (including 5-axis machines), lathes, multi-tasking turning centres and mill-turn machines, and horizontal borers with best-in-class specifications are all available...ready to install.

EXPERT SERVICE

Our dedicated, experienced and knowledgeable team is totally committed to improving your productivity, growth and success.

CUSTOMER SUPPORT AND SERVICES

We're there for you whenever you need us.

We help our customers operate at maximum efficiency by providing them with a range of tried, tested and trusted services - from pre-sales consultancy to post-sales support.



FIELD SERVICES

- On-site service
- Machine installation and testing
- Scheduled preventive maintenance
- Machine repair service



PARTS SUPPLY

- Supplying a wide range of original DN Solutions spare parts
- Parts repair service



TRAINING

- Programming, machine setup and operation
- Electrical and mechanical maintenance
- Applications engineering



TECHNICAL SUPPORT

- Supports machining methods and technology
- Responds to technical queries
- Provides technical consultancy

RESPONDING TO CUSTOMERS ANYTIME, ANYWHERE

DN Solutions Global Network

DN Solutions provides systems-based professional support services, before and after the machine tool sale, by responding quickly and efficiently to customers. By supplying spare parts, product training, field service and technical support, we provide the expert care, attention and assistance our customers expect from a market leader.



Global sales and service support network

4	Corporations
156	Dealer networks
51	Technical centers Technical Center, Sales Support, Service Support, Parts Support
200	Service posts
3	Factories





dn-solutions.com

Head Office

22F T Tower, 30, Sowol-ro 2-gil
Jung-gu, Seoul, Korea, 04637

Tel: +82-2-6972-0370/0350
Fax: +82-2-6972-0400

DN Solutions America

19A Chapin Road, Pine Brook
New Jersey 07058, United States

Tel: +1-973-618-2500
Fax: +1-973-618-2501

DN Solutions Europe

Emdener Strasse 24, D-41540
Dormagen, Germany

Tel: +49-2133-5067-100
Fax: +49-2133-5067-111

DN Solutions India

No.82, Jakkuar Village
Yelahanka Hobli, Bangalore-560064

Tel: + 91-80-2205-6900
E-mail: india@dncompany.com

DN Solutions China

Room 101,201,301, Building 39 Xinzhuan
Highway No.258 Songjiang District
China Shanghai (201612)

Tel: +86 21-5445-1155
Fax: +86 21-6405-1472

Sales inquiry

sales@dncompany.com

* For more details, please contact DN Solutions.

* Specifications and information contained within this catalogue may be changed without prior notice.